

Pure Freude
an Wasser

GROHE
WAVE



PERFECT TASTE
STRAIGHT FROM THE TAP
UNBOTTLED WATER BY GROHE BLUE HOME

www.vosoughishop.com
دفتر مرکزی : مشهد، بین قرنی ۳۱ و ۳۳
تلفن : ۰۵۱ - ۳۷۱۳۳۰۰۰

A close-up photograph of a young child with their mouth wide open, enjoying water being poured over their head. The child's eyes are closed, and their tongue is sticking out, capturing the water. The background is a bright, out-of-focus light, suggesting an outdoor shower or a water fountain. The overall mood is one of pure joy and refreshment.

WHERE WOULD
YOU EXPECT TO
FIND THE MOST
DELICIOUS WATER
ON EARTH?

A photograph of several white daisies with dark green centers, set against a vibrant blue background filled with out-of-focus light spots (bokeh). A dynamic splash of water is captured mid-air on the right side of the frame, with individual droplets visible. The overall mood is fresh and lively.

FALLING FROM
A **RAINCLOUD?**



EMERGING FROM
A FRESH, BUBBLING
SPRING?

PERHAPS IN
A BOTTLE?

OR NONE OF
THESE?



WE BELIEVE THE
ANSWER LIES
CLOSER TO HOME



WE CALL IT
**UNBOTTLED
WATER**

INTRODUCING
GROHE
BLUE HOME



WELCOME TO YOUR PRIVATE WATER SOURCE

.....

When was the last time you truly tasted water?
When you took a sip that left you thirsting for more?
That's what happens after your first encounter with GROHE
Blue Home: a beautiful and intelligent system that transforms
simple water into pure thirst-quenching pleasure, and your
kitchen into a meeting place for thirsty friends.



GROHE

99



First the sheer elegance of the tap catches the eye. But when you take a look behind the scenes, you'll discover the secret of GROHE Blue Home: the cooler – and the reason why drinking water will never be the same again.





Still waters run deep. If you prefer your water cool and still, nothing could be simpler: just push the top button. The LED lights up blue and your glass fills with pure refreshment.





STILL, MEDIUM OR SPARKLING: THE CHOICE IS ALL YOURS



How sparkling do you like your water? It's all a matter of taste. GROHE Blue Home has a simple and intuitive mechanism that lets you carbonate your drinking water at the touch of a button. Deliciously cool filtered water, just the way that you – and all your family – like it.



Sparkling – but not too much?
More of a medium sparkling?
Coming right up. Press both buttons
in sequence – the LED lights up
turquoise – to produce a finely
pearled stream of water.



Sparkling water, alive with bubbles. If that's your idea of thirst-quenching heaven, just press the lower button – the LED lights up green – for your perfect glass of water.

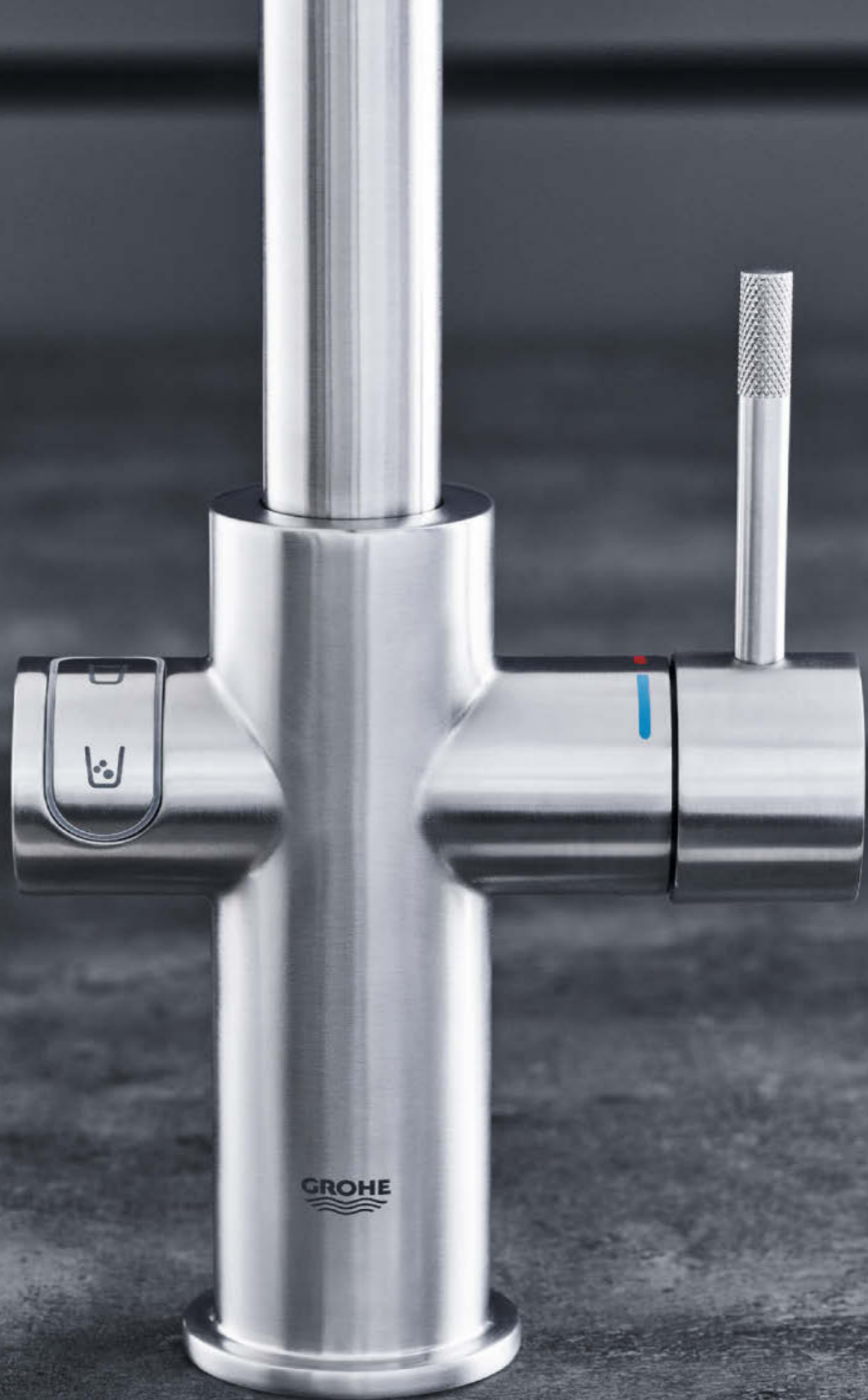



PERFECTLY **CHILLED** – JUST AS YOU LIKE IT

.....

Imagine the refreshing sensation of chilled water – cool and thirst-quenching. Ready and waiting for you at the touch of a button – at exactly the right temperature. Think of the glass misting over with minute water droplets and of that first delicious cold gulp.

Chilled water on demand – how refreshing is that then?

THE SHAPE OF **TOMORROW'S** DRINKING WATER

.....

Form and function come together in GROHE Blue Home, combining all the advantages of a high-end kitchen tap and a sophisticated water cooler. Add to that intuitive and timeless design and you are looking at the water source of the future.



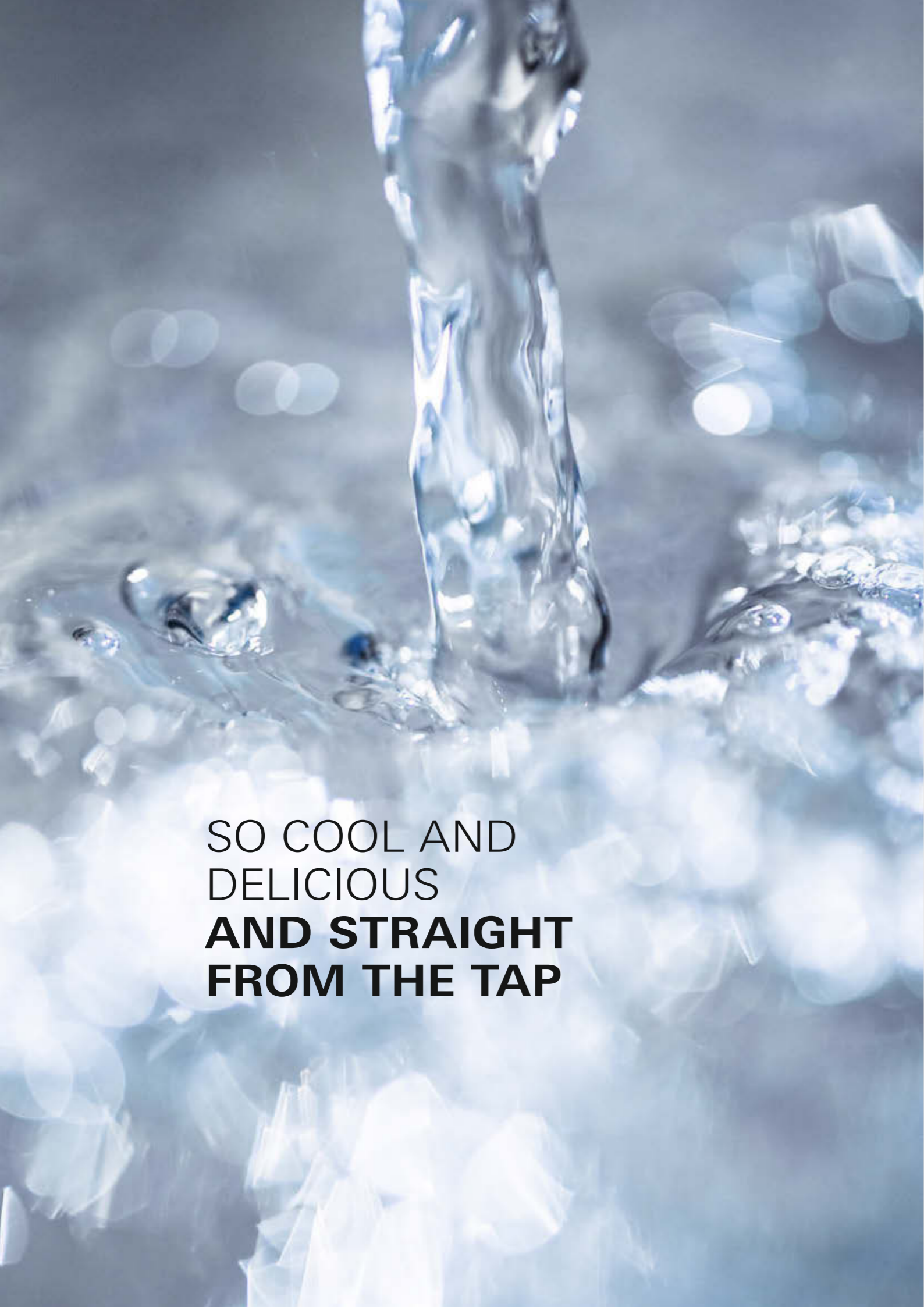

SO COOL AND
DELICIOUS
**AND STRAIGHT
FROM THE TAP**



THE INTELLIGENT HEART OF GROHE BLUE HOME

.....

First we came up with some state-of-the-art technology and then we hid it away. The GROHE Blue Home cooler is our undercover genius that takes the water, filters it, chills it and makes it sparkle, ready to fill your glass to the brim.



This is where it all happens: here you can adjust the temperature between 5° and 10° and insert the filter and the CO2 bottle.





THE MAGIC IS IN THE FILTER

For our GROHE Blue system we have worked with BWT, Europe's leading filtered water professionals, to ensure that our system produces an unparalleled, refreshing drinking experience. Our standard high performance S-Size filter comes with every GROHE Blue Home starter set. It uses a five-step filtration process to remove even the smallest particles from tap water, while leaving behind all the important minerals that benefit your health.

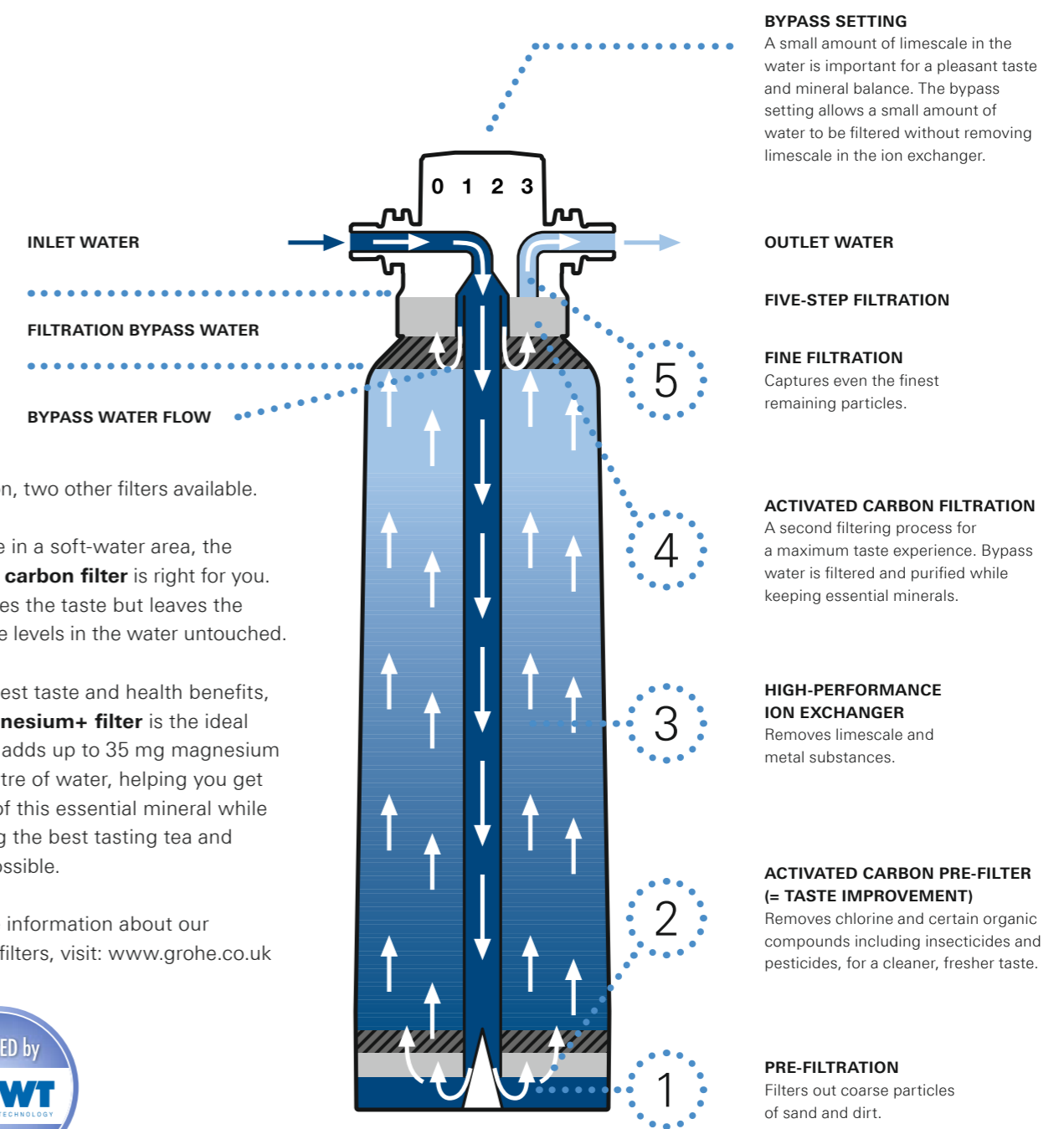

In addition, two other filters available.

If you live in a soft-water area, the activated **carbon filter** is right for you. It improves the taste but leaves the carbonate levels in the water untouched.

For the best taste and health benefits, **the magnesium+ filter** is the ideal choice. It adds up to 35 mg magnesium to each litre of water, helping you get enough of this essential mineral while delivering the best tasting tea and coffee possible.

For more information about our different filters, visit: www.grohe.co.uk





THE GUARANTEE FOR **PURE TASTE**



If you enjoy tea and coffee, you'll love them even more with GROHE Blue Home. Whether in your coffee machine or for making tea, the still water brings out the best in your favourite hot drinks. Thanks to the ultimate purity of the filtered water, the aromas can develop to the full – for an unforgettable café au lait, at the same time protecting your high-end kitchen appliances.





Visit our GROHE Blue shop:
<https://shop.grohe.co.uk>

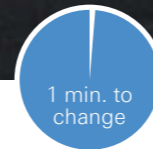

Watch the video and see how easy it is to replace the CO2 bottle.
www.grohe.co.uk

THE SIMPLEST WAY TO PERFECT BUBBLES

Nothing could be easier – or faster – than inserting the CO2 bottle. In less than a minute, you have a whole new supply of sparkling water – up to 60 l.

And when the time comes to replace the CO2 bottle, the display on the tap starts to blink, giving you ample warning.

The GROHE Blue Online shop or the GROHE Ondus app makes ordering replacement bottles and returning the empty ones simple and effortless.

NEW: WITH PULL-OUT FUNCTION

Our new GROHE Blue Home taps now come with a pull-out mousseur head for ultimate functionality and flexibility. Select from three contemporary tap shapes with a pull-out head, each with a hygienic mouser and two separate waterways, delivering both filtered and unfiltered water effortlessly.

Lead and
nickel free

Pull-out
mousseur

hygienic
mousseur
with 2 outlets



CONTROL VIA GROHE ONDUS APP

Control your GROHE Blue Home tap via smartphone app for total convenience. The GROHE Ondus App will not only let you know when the filter or CO2 need replacing, but can reorder for you automatically. Use it to pour water and monitor your consumption via personal fitness apps.

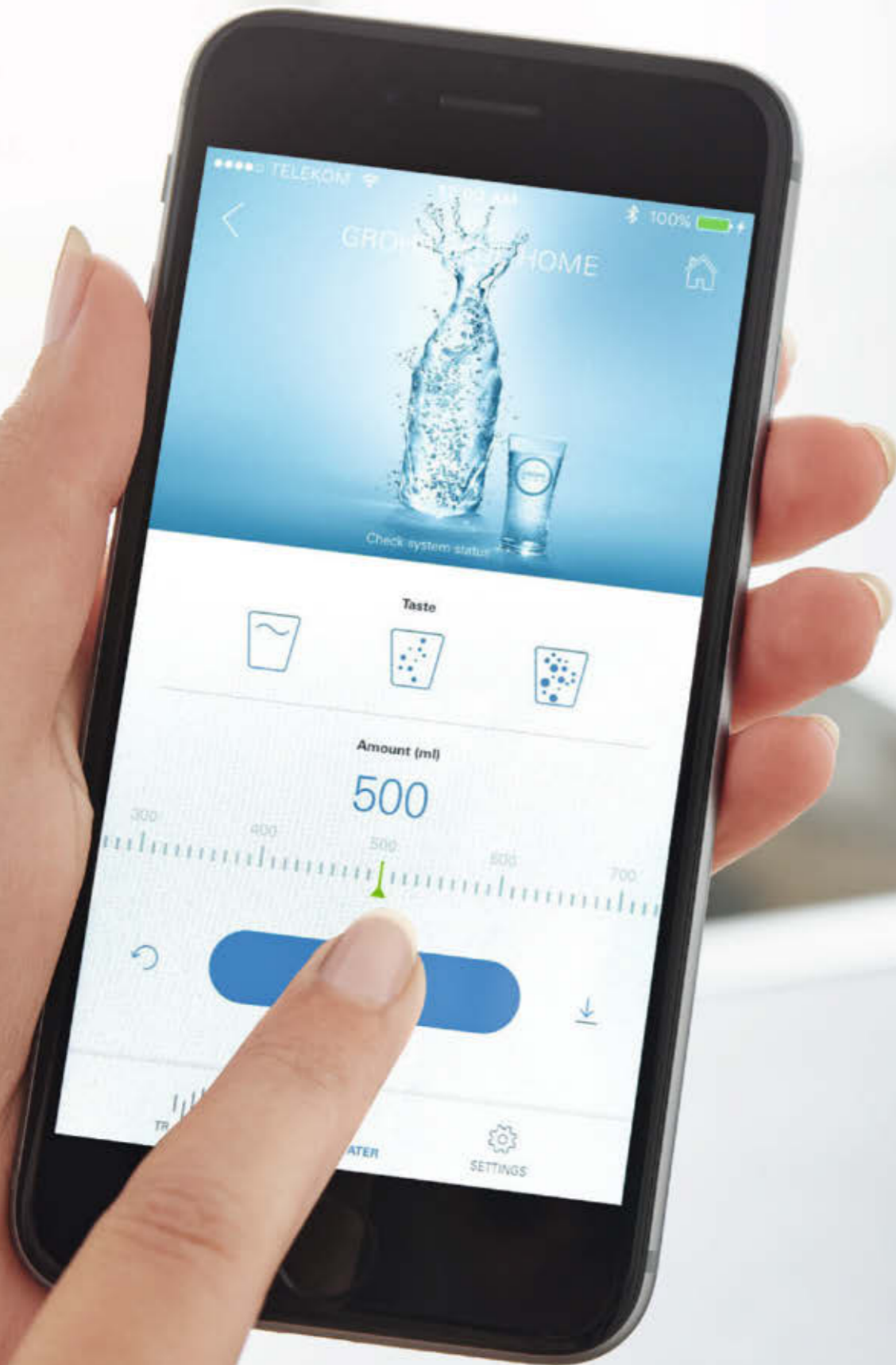

System requirements

iPhone with iOS 9.0 or higher / smartphone with Android 4.3 or higher

Mobile devices and GROHE Ondus App are not included in delivery and have to be ordered separately via an authorised Apple store/store/iTunes or Google Play store.

The Bluetooth® word mark and logos are registered trademarks owned by Bluetooth SIG, Inc. and any use of such marks by Grohe AG is under license. Other trademarks and trade names are those of their respective owners. Apple, the Apple logo, iPod, iPod Touch, iPhone and iTunes are trademarks of Apple Inc., registered in the U.S. and other countries. Apple is not responsible for the function of this device or its compliance with safety and regulatory standards.

ENJOY **ALL THE**
BENEFITS OF
GROHE BLUE HOME



HOME DELIVERY MEANS FROM TAP TO TABLE

.....

What could be easier – and more convenient – than drawing your drinking water straight from the tap? Life just became a lot simpler.



Space: we'd all like to have more of it. And in the fridge it's in especially short supply. Try squeezing enough water bottles in to keep the family going for a weekend or when friends come round, because nobody wants to drink lukewarm water on a summer's day. Thank goodness GROHE Blue Home delivers chilled water on demand.

Just think for a moment about the effort it takes to ensure a constant supply of bottled water at home. Queuing up to buy it, lugging the heavy crates and bottles home (how's your back, by the way?), carrying them up the stairs and storing them. And before you know it, it's time to take the empties back, before starting the process all over again.

Time: something else that is precious. So why would anyone want to spend those precious minutes driving to supermarkets, looking for parking spaces and returning bottles. GROHE Blue Home means less frustration, more free time.

And here's another thought: when every member of the family prefers a different water, that's three kinds you have to buy. Not with GROHE Blue Home. You can have sparkling, medium and still – with just one tap.



BRAND A

Cost per year:
1620,-

BRAND B

Cost per year:
1188,-

BRAND C

Cost per year:
1080,-

GROHE BLUE HOME

Cost per year:
540,-

-50%

Sample calculation

Annual costs for a family of four with an average consumption of 1.5 litres per person per day.

SAVE IN THE LONG RUN AND IN THE SHORT

GROHE Blue Home is an investment in more ways than one. When you look at the costs of providing quality drinking water for your family and friends 365 days a year, you'll see how quickly you start to save in comparison to bottled water.

It's a simple piece of arithmetic. You'll soon be saving money with every glass you drink. And that's not counting the time and effort that you save as well.

When you register your GROHE Blue Home purchase online, we'll extend your warranty to 3 years, adding further security to your investment.



THE BEST PACKAGING FOR WATER: **NO PACKAGING** AT ALL

.....

We are responsible for our small blue home, the earth. It demands of us that we care for its environment and save its precious water resources. At GROHE Blue Home we have a goal: to help save the planet one glass at a time.



It might seem obvious, but in a world that is slowly sinking in a sea of plastic, the issue of the practically indestructible plastic bottles is becoming more urgent than ever.

Not only that, it takes an astonishing 7 litres of water just to produce a single litre of bottled water, not to mention the energy used and the CO2 emissions created.

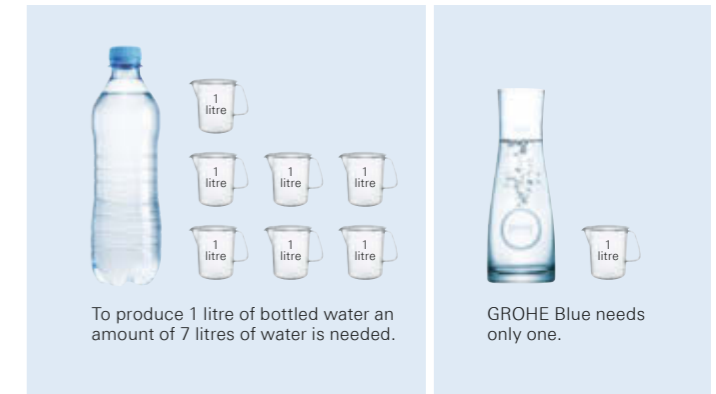

So do we really need bottled water? At GROHE we believe we have found the solution in GROHE Blue Home. We commissioned the University of Göttingen to carry out in-depth research that made comparisons of CO2 emissions. The result: a huge reduction of 61% compared to bottled water.

So you can have pure water enjoyment without compromising your green ideals.

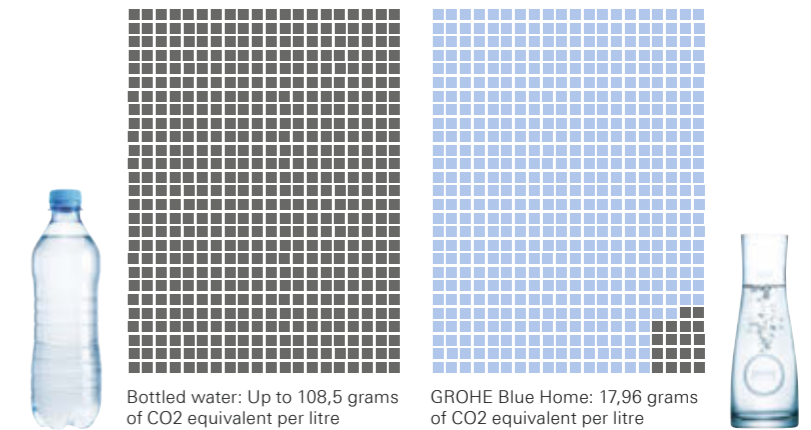

BRING **MORE HEALTH** INTO YOUR LIFE

.....

Everyone knows that the basis for good health is drinking enough water. It's vital for your brain and good for your skin. So if it's beauty and brains that you want, you need look no further than GROHE Blue Home.



Magnesium and vitality go together. With the optional magnesium+ filter, you can have more of this important mineral in your diet. 2 litres of GROHE Blue Home contain as much magnesium as 4 apples – up to 35mg per litre. Magnesium also enhances the flavour of the water, so it tastes good as well as does you good.



The recipe for taste and health: exclusive water recipes from GROHE Blue Home. Based on all natural ingredients and developed by GROHE and BWT, the Water Recipe Book is brim-full of mouth-watering drinks. Tested and approved by water-sommeliers.



How much is enough? Experts recommend that we drink at least 2 litres a day. Yet with GROHE Blue it's so easy and pleasurable to fill a glass of refreshing water that many people find themselves returning for more.



YOUR WATER SOURCE FOR WHEN YOU'RE ON THE MOVE: **GROHE TO GO**



You don't need to stay at home to enjoy GROHE Blue Home. Discover the stylish and practical bottles for when you're out and about. In unbreakable plastic or elegant brushed aluminium, these bottles ensure you'll always be able to enjoy delicious tasting water wherever you are. Whether on your way to work or a workout, these bottles are beautiful enough to never leave your side.

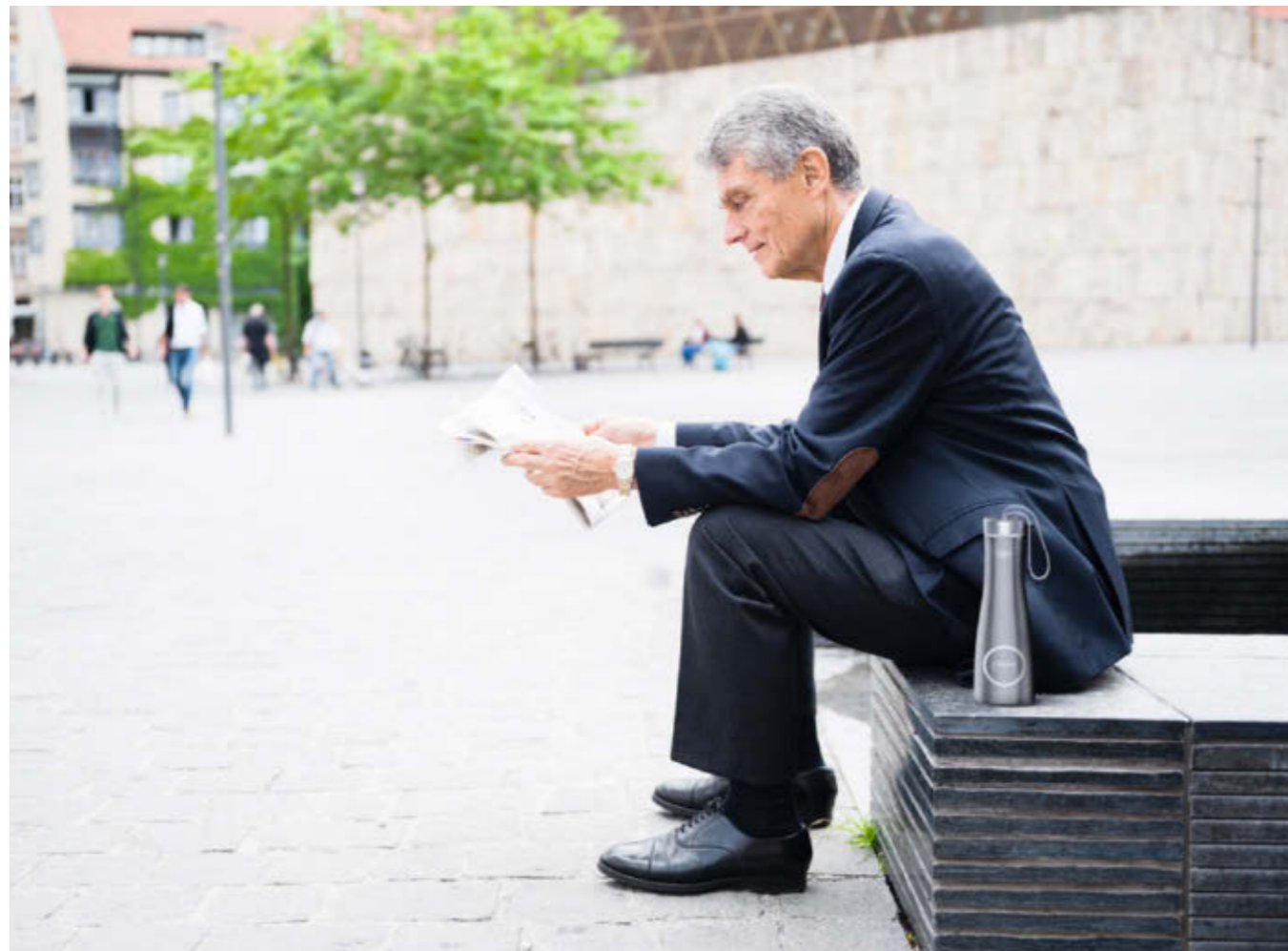

Visit our GROHE Blue shop:
<https://shop.grohe.co.uk>



TAKING A **CLOSER**
LOOK AT GROHE
BLUE HOME





DESIGNED TO LOOK
BEAUTIFUL IN
EVERY KITCHEN



We designed the iconic GROHE Blue Home with a view to creating an aesthetic centrepiece for your kitchen. To ensure that your tap harmonises with your kitchen, whatever your chosen style, you can select from a number of different forms. There are three timeless and elegant options: the L, C and U-shaped spouts, available in two stylish finishes – Chrome and SuperSteel.



THE TAP THAT COMPLEMENTS **ALL OTHERS**

If you already have a high-end tap in your kitchen and don't wish to replace it, then GROHE Blue Home Mono is the perfect choice for you. It fits perfectly alongside your existing tap, a source of deliciously fresh and sparkling filtered water.



Separated inner water ways for unfiltered tap and filtered drinking water.



THE **ULTIMATE** IN DESIGN AND FUNCTION

GROHE Blue Home is the symbiosis of elegant, timeless design and innovative features that make it a pleasure to use. Lovely as it is to look at, there's much more to GROHE Blue Home than meets the eye.

When the time comes to replace the filter, the display on the tap will alert you with an orange, blinking light.



A white, blinking light alerts you when it's time to replace the CO2 bottle.



Push button with illuminated LED ring for still, medium and sparkling water.



Spout, turnable by 150°



Hygienic mousseur with two outlets and optional pull-out

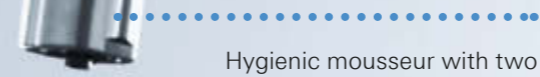

Forward rotating lever with knurled structure for better grip



Cartridge with GROHE SilkMove technology for normal tap water





The GROHE Blue Home cooler is slim and adaptable, making it simple to find the ideal space for it in your kitchen. It can be fitted directly below the sink or within a radius of 2.5 meters, e.g. in a 30 cm wide towel cabinet.

EVERY SPACE CAN BE A HOME FOR GROHE BLUE HOME.

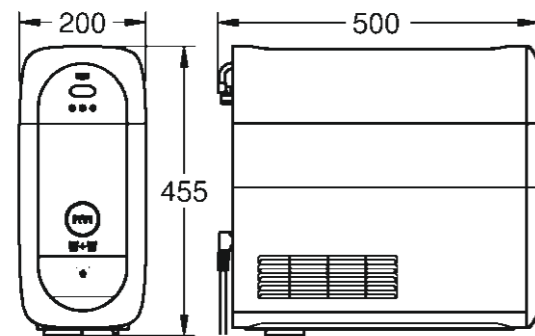

INSTALLING THE COOLER: THE LAST STEP TO PERFECT REFRESHMENT

1



Place tap and mount with fixation set below the cabinet.

2



Place ventilation template and drill ventilation hole accordingly.

3



Screw filter into filter head and place cooler below the cabinet into the drilled holes.

4



Connect hoses to the tap and cooler. Afterwards open the angle valves before connecting power supply.

5



Screw in CO2 bottle and close front with cover. Rest the cooler for about 20 minutes to cool down the water.

6



Adjust the software to the correct filter capacity setting.



THE GROHE BLUE HOME PRODUCT PORTFOLIO AND RANGE OF ACCESSORIES



31 539 000 / 31 539 DC0
GROHE Blue Home
L-spout Starter kit with pull-out



31 541 000 / 31 541 DC0
GROHE Blue Home
C-spout Starter kit with pull-out



31 543 000 / 31 543 DC0
GROHE Blue Home
U-spout Starter kit with pull-out

Colour options:

● 000 | StarLight Chrome | ● DC0 | SuperSteel



GROHE
SilkMove



GROHE
StarLight



Enhanced
Water



Swivel
Stop



Comfort
Height





31 454 001 / 31 454 DC1
GROHE Blue Home
L-spout Starter kit
31 539 000 / 31 539 DC0
GROHE Blue Home
L-spout with pull-out

31 455 001 / 31 455 DC1
GROHE Blue Home
C-spout Starter kit
31 541 000 / 31 541 DC0
GROHE Blue Home
C-spout with pull-out

31 456 001 / 31 456 DC1
GROHE Blue Home
U-spout Starter kit
31 543 000 / 31 543 DC0
GROHE Blue Home
U-spout with pull-out

31 498 001 / 31 498 DC1
GROHE Blue Home
Mono Starter kit



40 404 001
GROHE Blue Home
S-Size Filter
Capacity 600 l at 15° KH



40 547 001
GROHE Blue Home
Activated Carbon filter
For regions with water hardness
< 9° KH Capacity 3000 l



40 691 001
GROHE Blue Magnesium+
filter with magnesium and
premium taste
capacity 400 l at 15° KH



40 434 001
GROHE Blue Home
cleaning cartridge
40 694 000
adapter for GROHE Blue
BWT filter head only to be used
in combination with 40 434 001

EACH GROHE BLUE HOME CONTAINS:



CARBONATOR
GROHE BLUE HOME

CO2 BOTTLE 425 g

S-SIZE FILTER



40 422 000
GROHE Blue CO2 bottle
425 g 4 pieces

Available as:
40 687 000
GROHE Blue CO2 Refill bottle
425 g 4 pieces



40 437 000
GROHE Blue Glass 6 pieces



40 405 000
GROHE Blue Glass carafe



40 848 000 / 40 848 SD0
GROHE Blue drinking bottle
plastic
GROHE Blue drinking bottle
stainless steel

Colour options:

● 000/001 | StarLight Chrome | ● DC0/DC1 | SuperSteel



GROHE
SilkMove



GROHE
StarLight



Enhanced
Water



Swivel
Stop



Comfort
Height

Visit our GROHE Blue shop:
<https://shop.grohe.co.uk>

HERE ARE THE **ANSWERS** TO ALL YOUR QUESTIONS



How much space do I need to install GROHE Blue Home?

The cooler is 20 cm wide and 50 cm deep. This means that the whole system can fit comfortably inside a standard 60 cm or even in a 30 cm kitchen cabinet.

When do I need to change the filter?

The filter has to be changed at least every 12 months, or when it has run out, whichever is sooner. An LED display in the tap's left handle makes it easy to tell when filter capacity is running low. A flashing light indicates less than 10% capacity and a rapidly flashing orange light indicates 1% capacity, meaning the filter cartridge must be changed. If the device is integrated to the GROHE Ondus app it will remind you to change the filter by sending a push notification.

When do I need to change the CO2 bottle?

As soon as the water does not sparkle anymore. To give a heads-up indication the LED display in the tap's left handle flashes white shortly before the CO2 bottle needs to be replaced. The system will also send a push notification via the GROHE Ondus app.

Where can I buy filter and CO2 bottles?

Visit our online GROHE Blue shop for all replacement filters, CO2 bottles and accessories or use the GROHE Ondus app to order refills with your smartphone.

How do I change the filter?

The filter can be easily changed simply by unscrewing it and screwing in the new filter in its place. You don't even need to turn the water supply off.

How do I change the CO2 bottle?

The CO2 bottle can also be changed simply by unscrewing it and screwing in the new bottle in its place. Simple!

How can I dispose of the filter?

The filter can be easily disposed of as normal plastics.

What is the capacity of the CO2 bottle?

The 425 g bottle produces 60 litres of full sparkling water.

What happens if I do not use GROHE Blue Home for an extended period of time?

GROHE recommends not leaving the filter system out of service for extended periods of time. If the GROHE Blue filter system is not used for a few days, the filter system must be rinsed with at least four liters of water. If you leave the system unused for more than four weeks then the system has to be cleaned with the GROHE Blue Bio-Clean cleaning liquid 40 434 001 and the filter must be replaced.

Why should I drink GROHE Blue water? I keep hearing that tap water is top quality, so why should I purchase GROHE Blue Home?

GROHE Blue purifies the already good quality tap water, and of course gives you the option of chilled, carbonated water too. Substances which are important for the body such as calcium and magnesium are retained, while the limescale content is reduced and elements which affect taste such as heavy metals (iron, copper), chlorine and organic substances (pesticides) are filtered out. Water supply companies just guarantee drinking water quality to the point where it enters your home. Impurities caused by the house piping are eliminated by the GROHE Blue filter.

What do I need to consider when installing GROHE Blue Home?

Don't forget that the cooler requires sufficient air ventilation and requires a warm air exhaust outlet at the bottom of the cabinet. The cut-out template is included in every product set.

GROHE: A WHOLE WORLD OF **INTELLIGENT DESIGN** FOR THE KITCHEN

Discover the many beautiful and functional taps in our wide selection.

They range from sleek, minimalistic forms that are timeless in their appeal, to striking styles that make a bold design statement.

And they come with many ingenious features and functions for ease and pleasure of use. For example with our pull-out mousseurs and sprays which are both convenient and time-saving. Or easy-touch taps that can be operated with just a fingertip.

Whatever your needs, GROHE offers you all the choice, comfort and flexibility that you could wish for.



Find more on [grohe.co.uk](https://www.grohe.co.uk)



REGISTER ONCE, BENEFIT TWICE!

Register your GROHE Blue Home System now! And receive an extended warranty from 2 to 3 years.

Product-registration: <http://product-registration.grohe.com>

ORDERING FROM HOME OR ON THE GO: **DONE**

Visit our GROHE Blue Online shop to see our exclusive range of carafes and glasses, drinking bottles for on-the-go, as well as replacement filters and CO2 bottles.



Visit our GROHE Blue shop:
<https://shop.grohe.co.uk>

Follow us



QUALITY



TECHNOLOGY

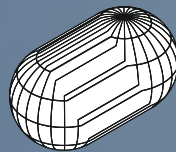

FORTUNE®
**CHANGE
THE WORLD**
2017

DESIGN

300+
DESIGN AWARDS

SUSTAINABILITY



Winner 2017

From FORTUNE, September 15, 2017. FORTUNE is a registered trademark of Time Inc., used under license. FORTUNE and Time Inc. are not affiliated with, and do not endorse, products or services of, GROHE.

GROHE Limited
World Business Centre 2
Newall Road
London Heathrow Airport
Hounslow
Middlesex
TW6 2SF
Tel: 0871 200 3414
Fax: 0871 200 3415
email: info-uk@grohe.com

© 08/2018 – Copyright by GROHE

www.vosoughishop.com

PART OF **LIXIL**