

www.vosoughishop.com

دفتر مرکزی : مشهد، بین قرنی ۳۱ و ۳۳

تلفن : ۳۷۱۳ ۳۰۰۰ - ۰۵۱

*Pure Freude
an Wasser*

GROHE
Wasser

YOUR KITCHEN

2020/21



**OPENWATERHEATER**

The perfect flow in combination with open water heaters.

**STOPVALVE**

Includes a dishwasher shut-off valve on the tap body.

**PREWINDOW**

To open the window, just lift up the tap and lay it flat on the surface.

**COMFORTHEIGHT**

Height of the spout allows easy filling of large pots.

**ENHANCED WATER**

Superior-quality water directly from the kitchen tap – saving time, money and the environment.

**PULL-OUT MOUSSEUR SPRAY**

Increases operating radius of the tap and offers different sprays.

**CHILDLOCK**

Integrated safety mechanism prevents unintentional opening by young children.

**TITANIUM INSIDE**

All boilers in our GROHE Red collection are made from titanium.

**EASYEXCHANGE**

The aerator is easy to install and de-install using just a coin.

**REALSTEEL**

Made of solid stainless steel, a robust material with anti-bacterial properties.

**EASYTOUCH**

Just touch the tap at any point with your wrist, elbow or just your fingertip to turn the tap ON and OFF.

**FOOTCONTROL**

Just touch the bottom side of the cabinet with a gentle tap of your foot to turn the tap ON and OFF.

**PULL-OUT MOUSSEUR**

Increases the operating radius of your tap.

**PROFESSIONAL-SPRAY**

Features a 360° spring arm and easy switching between the spray and mousseur.

**PULL-OUT DUAL SPRAY**

Increases operating radius of the tap and offers easy switching between mousseur and the spray.

**SWIVELSTOP**

Limited turn angle prevents flooding.

**EASYDOCK**

Guaranteed easy retraction and smooth docking for your pull-out spray head, every time.

**SPEEDCLEAN**

Remove limescale with a single wipe.

**FORWARD ROTATING LEVER**

Forward rotating lever prevents the lever hitting the backsplash.

**ZERO (Lead+Nickel Free)**

No contact of water with lead and nickel due to isolated inner water ways.

**GROHFLEXX**

With flexible, hygienic GrohFlexx kitchen santoprene hose.

**EASYDOCK M**

Integrated magnet for seamless docking of the spray head.

**AQUAGUIDE**

Variable spout end for adjustment of water flow.

**GROHE SILKMOVE**

Smoothest handling for effortless precision and ultimate comfort for a lifetime.

**GROHE SILKMOVE ES**

The intelligent combination of energy saving and effortless water control.

**GROHE QUICKFIX**

Faster, easier and hassle-free, GROHE QuickFix cuts installation time by up to 40 %.

**GROHE COOLTOUCH**

No scalding on hot surfaces thanks to 100 % GROHE CoolTouch.

**GROHE STARLIGHT**

Made-to-last surfaces ranging from precious matt to shiny like a diamond.

**GROHE ECOJOY**

Save precious resources and enjoy 100 % water comfort.

**GROHE WHISPER**

Innovative water technology delivering whisper-quiet acoustics.

HANDS ON FEATURES

Accommodating your every wish and desire, GROHE watersystems and kitchen taps include user-centric features and ingenious details that make all the difference. More choice, more comfort and more flexibility; which is why our products are such a pleasure to use.

GROHE BRAND	2
GROHE KITCHEN FEATURES	9
GROHE WATERSYSTEMS	37
GROHE PREMIUM LIFESTYLE COLLECTIONS	99
GROHE PERFORMANCE LINES	137
GROHE KITCHEN SINKS	165
GROHE SOAP DISPENSERS	224

Welcome to the smartest product portfolio in the industry,
where kitchen taps, watersystems, sinks, accessories and
consumer-oriented features combine with outstanding design.
Enjoy the ultimate GROHE kitchen experience.



QUALITY

From the first design sketch to the final product to after-sales services: Our customers can rely on our Made in Germany sense of perfectionism.

"No.1 most trusted brand in the sanitary industry" – Wirtschaftswoche, 2017

TECHNOLOGY

We constantly drive innovation to enrich your everyday water experience, delivering smart solutions on the path of the digitization of water.

"Top 50 companies to change the world" – Fortune Magazine, 2017

DESIGN

Our highly awarded design DNA's recipe for success is simple: Merging the contemporary and the timeless into products that feel like they were designed just for you.

Over 400 design awards won since 2003

SUSTAINABILITY

Water is our passion. We care about every drop and our CSR commitment goes even beyond one element alone: We strive to protect all of our planet's resources for future generations.

CSR Award winner of the German Government, 2017



GROHE KITCHEN SYSTEMS

PERFECT SOLUTIONS FOR THE CENTRE OF YOUR KITCHEN



GROHE ACCESSORIES



GROHE COMPOSITE SINKS



GROHE STAINLESS STEEL SINKS



GROHE PVD SINKS



GROHE WATERSYSTEMS



GROHE BLUE PURE



GROHE TAPS



GROHE BLUE / RED WATERSYSTEMS



GROHE WASTE SYSTEMS

GROHE BRAND	2
› GROHE KITCHEN FEATURES	9
SMARTCONTROL	10
MAGNETIC DOCKING	11
FOOTCONTROL	12
EASYTOUCH	14
TYPES OF SPOUTS	16
POWERFUL SPRAYS	20
FINISHES	28
PREWINDOW	32
OPENWATERHEATER	33
ZERO (LEAD+NICKEL FREE)	34
STOPVALVE	35
GROHE WATERSYSTEMS	37
GROHE PREMIUM LIFESTYLE COLLECTIONS	99
GROHE PERFORMANCE LINES	137
GROHE KITCHEN SINKS	165
GROHE SOAP DISPENSERS	224

GROHE KITCHEN FEATURES

Accommodating your every wish and desire, GROHE watersystems and kitchen taps include user-centric features and ingenious details that make all the difference. More choice, more comfort and more flexibility: which is why our products are such a pleasure to use.

GROHE SMARTCONTROL

SmartControl kitchen puts precise control at your fingertips. Instead of a lever you start and stop the water flow by pushing the button on the spray – great for those moments when you have your hands full as it can be operated just by your wrist or elbow. To control the flow just turn the valve, changing smoothly from an eco-flow to a powerful jet.

To adjust the water temperature, turn the valve at the body gently to the left or right. The pull-out spray head design gives you great flexibility, and with this feature available in three designs and a number of attractive finishes, the perfect model for your kitchen scheme is at your fingertips, too.



MAGNETIC DOCKING

Thanks to powerful integrated magnets the pull-out spray head retracts easily and smoothly to the perfect position every time after use.



30 270 000 + 30 309 000
 Essence
 Sink mixer high spout
 with pull-out dual spray
 + FootControl retro-fit set



FOOTCONTROL

Just touch the bottom side of the cabinet with a gentle tap of your foot to turn the tap ON and OFF.



GROHE FOOTCONTROL

For kitchens where time is of the essence and convenience is a must, why not go hands-free? GROHE's new FootControl taps can be turned On and Off with a gentle tap of your foot on the base unit, leaving your hands free and your tap spotless at all times. You can retro-fit the feature to any GROHE pull-out kitchen tap. To say goodbye to germs, mess and hassle, simply tap your feet!



30 309 000
 Retro-fit set
 for upgrading any GROHE pull-out kitchen tap
 with **FootControl** technology.

Available on following lines:
 K7, Zedra, Minta, Essence, Parkfield, Eurodisc Cosmopolitan, Eurodisc, Concetto, Eurostyle Cosmopolitan, Eurosmart Cosmopolitan, Eurosmart

Except for low pressure variants, SmartControl and GROHE EasyTouch taps.

GROHE EASYTOUCH

Kitchens are hands-on places, where multi-tasking is a must. Why not make life easier for yourself with a GROHE touch-activated tap? We've developed a choice of two innovative solutions that let you control the flow of water without using your hands, making your kitchen more hygienic, convenient and instinctive to use. GROHE taps can be activated with a simple touch of the wrist or elbow. Leave your hands free and keep your tap sparkling clean. Change the way you control your kitchen with just a single touch.

The kitchen is the heart of your life at home – and let's face it, sometimes life gets messy. With GROHE's innovative EasyTouch taps sticky fingers won't slow you down and cross-contamination is a thing of the past. Hidden GROHE technology lets you start and stop the flow of water with a single tap of your arm, wrist or the back of your hand, anywhere on the spout. No more greasy fingerprints or struggling to turn a lever with your elbow.



EASYTOUCH

Just touch the tap at any point with your wrist, elbow or just your fingertip to turn the tap ON and OFF.

30 219 002
Zedra Touch
Electronic sink mixer
C-Spout
with pull-out triple spray

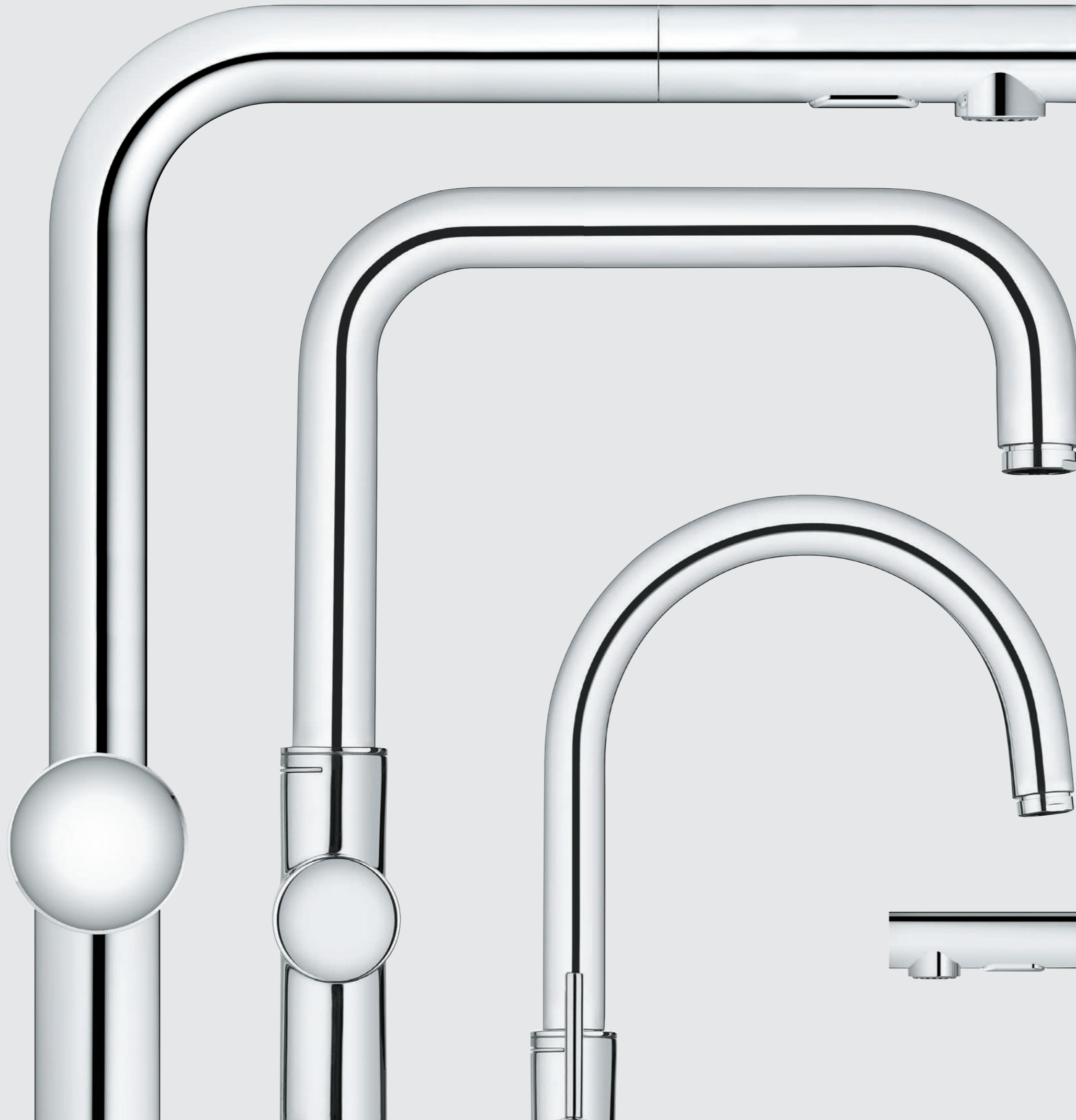

TYPES OF SPOUTS

Our range of spout options let you combine comfort and convenience with great design flexibility. Our spouts come in a variety of heights, from a compact low spout for small spaces to a high spout perfect for filling pots, as well as in a choice of U-, C- or L-shape to perfectly suit your style. Need even more flexibility? Our spouts that swivel or feature pull-down spray heads offer extra reach, power and performance for busy kitchens.



POWERFUL SPRAY FUNCTIONS

Get some power behind your daily tasks with GROHE's range of professional and pull-out sprays. Enjoy an increased operating radius for maximum convenience, and on many models you can also switch between two spray functions for even greater flexibility. The GROHE EasyDock function with glideflex hose ensures the spray docks smoothly back into position, and on some professional spray models GROHE EasyDock M uses a magnet to guide the spray head back into place effortlessly, every time. When your work is done enjoy the easy-clean advantage of GROHE's SpeedClean feature – available on all pull-out sprays with two spray functions – that lets you clean limescale from the head with a simple sweep of your finger.



31 395 DC0
Eurocube
Professional sink mixer



PROFESSIONAL SPRAY

Features a 360° spring arm and easy switching between the spray and mousseur.



new

TRIPLE SPRAY TECHNOLOGY



GROHE Blade Spray



NEW INNOVATIVE SPRAY

- 1 Laminar Spray**
Clean spray without addition of air that guarantees no splashing
- 2 Shower Spray**
Powerful spray with addition of air to rinse fruits and vegetables
- 3 GROHE Blade Spray**
Very condensed spray with up to 70 % less water consumption compared to shower spray, effective for cutting through debris (apply more force to shower spray button)
- 4 Pause Button**
Allows to pause the water flow while operating the tap (hold button to pause and release for water flow)

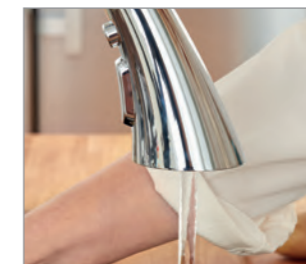

Laminar Spray



Shower Spray



PULL-OUT DUAL SPRAY

Increases operating radius of the tap and offers easy switching between mousseur and the spray.



30 270 000
Essence
Sink mixer high spout
with pull-out dual spray



GROHFLEXX
With flexible, hygienic GrohFlexx kitchen santoprene hose.



30 294 000
Essence
Professional sink mixer
high spout
with dual spray



MAGNETIC DOCKING
Integrated magnets for seamless docking of the spray head.





EASYDOCK

Guarantees easy retraction and smooth docking for your pull-out spray head, every time.

32 663 003
Concetto
Sink mixer high spout
with pull-out mousseur



PULL-OUT MOUSSEUR

Increases the operating radius of your tap.

GROHE COMPOSITE

Durable and resilient, GROHE composite sinks use quartz, the hardest part of granite, to create a seamless sink that is resistant to scratches, dents, heat and stains, for a beautiful kitchen centrepiece tough enough for any job.



GROHE STAINLESS STEEL

Put sleek, strong, stainless steel at the heart of your kitchen with a GROHE kitchen sink. Our above-standard grade stainless steel offers great performance, crisp angles and generous capacity in a timeless, hardwearing material.



GROHE PVD

Made-to-last surfaces ranging from precious matt to shiny like a diamond. The special recipe to success lies in our long-lasting surface quality. GROHE uses state-of-the-art technology to deliver exceptional quality finishes. The physical vapour deposition (PVD) process ensures that the surface composition is three-times harder, delivering glistening gold or sophisticated stainless steel finishes. As well as being harder, the surface is also ten times more scratch resistant, so it can be cherished for a lifetime.



GROHE PVD

UNRIVALLED, HARD AND SCRATCH RESISTANT

OUR HIGH-END PVD TECHNOLOGY BRINGS OUR COLOURS TO LIFE

When it comes to a good design strategy, the choice of colours plays a vital part. But not only the colour, the quality of the finish is equally important. Especially in the world of bathroom and kitchen solutions and where surfaces ought to last for a long time, excellent, highly resistant finishes distinguish good products from great ones. GROHE's aspiration to always produce only the best drove us to choose a special technology that assures, not simply the best, most brilliant colours, but a durable coating of the highest quality. Our aim: to offer our consumers long-lasting water enjoyment. Next to the resistance of the material, it was also about the look of the colour itself: we wanted to make Brushed Hard Graphite as dark grey as possible and give our golden finishes the brilliance they deserve. That was the task for our technology team. In close collaboration with the GROHE design team, they achieved exceptional results working with a great new technology: PVD.



GROHE PVD

10 x more scratch resistance
3 x more surface hardness



GROHE COLOURS

 000 StarLight Chrome	 GL0 Cool Sunrise	 DA0 Warm Sunset	 A00 Hard Graphite	 BE0 Polished Nickel
 DC0 SuperSteel	 GN0 Brushed Cool Sunrise	 DL0 Brushed Warm Sunset	 AL0 Brushed Hard Graphite	 EN0 Brushed Nickel





GROHE PREWINDOW

Having your sink area in front of a window provides you with a view to soothe and inspire you while preparing food or washing dishes. With the GROHE PreWindow solution you can open and clean your window easily. Just lift up the tap and lay it flat on the surface – job done.

Available on following lines:
Eurodisc Cosmopolitan, Concetto, Eurostyle Cosmopolitan,
Eurosmart Cosmopolitan



GROHE OPENWATERHEATER

In kitchens that are a long way from the central hot water supply, small boilers directly under the sink are really common. In these specific cases a special kitchen mixer is required. Hot water can run immediately and this solution offers you the perfect flow in combination with open water heaters.

Available on following lines:
Minta, Eurodisc Cosmopolitan, Concetto, Eurostyle Cosmopolitan,
Eurosmart Cosmopolitan





GROHE ZERO (Lead+Nickel FREE)

No contact of water with lead and nickel due to isolated inner water ways.

Available on following lines:
SmartControl, Zedra, Eurodisc Cosmopolitan, Concetto, Eurostyle Cosmopolitan, Eurosmart Cosmopolitan, Eurosmart, Baulines



GROHE COOLTOUCH

No scalding on hot surfaces thanks to 100 % GROHE CoolTouch.

Available on following lines:
SmartControl, Zedra, Eurodisc Cosmopolitan, Concetto, Eurostyle Cosmopolitan, Eurosmart Cosmopolitan, Eurosmart, Baulines



GROHE STOPVALVE

This small shut-off at the base of your kitchen-mixer turns off the water supply for the dishwasher or washing machine for maximum convenience day-to-day. One quick turn and the water is safely shut-off.

Available on following lines:
Minta, Concetto, Eurosmart Cosmopolitan, Eurosmart



GROHE BRAND	2
GROHE KITCHEN FEATURES	9
› GROHE WATERSYSTEMS	37
GROHE BLUE	42
GROHE BLUE HOME	44
GROHE BLUE PROFESSIONAL	62
GROHE BLUE PURE FILTER TAPS	68
GROHE WASTE SYSTEMS	72
GROHE BLUE ACCESSORIES	74
GROHE RED	80
GROHE RED ACCESSORIES	94
GROHE PREMIUM LIFESTYLE COLLECTIONS	99
GROHE PERFORMANCE LINES	137
GROHE KITCHEN SINKS	165
GROHE SOAP DISPENSERS	224

GROHE WATERSYSTEMS

Water is the source of life, fresh, free-flowing and essential. Our range of watersystems offers a tailored drinking experience of purity and convenience that will turn water into a source of health and enjoyment in your home.



GROHE
BLUE

Page 42

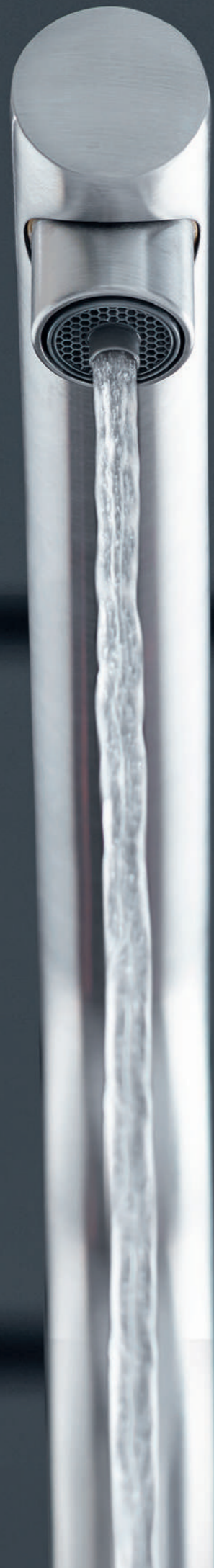

GROHE
RED

Page 80



GROHE BLUE

Enjoy the benefits of fresh filtered water wherever you are. In the comprehensive GROHE Blue range you'll find models designed for every situation – get filtered, still or sparkling water on tap in your own kitchen or select a model ideal for office and professional use. Just need filtered water in your kitchen? Then our entry-level tap is the perfect choice. All versions of GROHE Blue come with the same sleek modern design values, intuitive operation and convenience built in.



GROHE BLUE HOME

The superior solution for your private home with pull-out mousseur and GROHE Ondus app control.

PAGE 44



GROHE BLUE PROFESSIONAL

The excellence for offices and small or medium enterprises.

PAGE 62



GROHE BLUE PURE FILTER TAPS

The perfect choice for the entry level. Just perfectly filtered water.

PAGE 68



GROHE BLUE HOME

YOUR PRIVATE WATER SOURCE

CHILLED AND SPARKLING

Do you like your chilled drinking water still or sparkling? Somewhere in between? With GROHE Blue the choice is all yours. First the water is filtered to remove impurities. Then it is chilled to create that mountain-fresh taste. And when you turn on the tap a simple touch of a button lets you choose whether still, medium sparkling or sparkling water flows into your glass.

Fresh water tailored to your exact taste, flowing straight from the tap – it's as easy as 1, 2, 3. While the right-hand lever on a GROHE Blue tap mixes hot and cold water as normal, a handle on the left serves the chilled and filtered water and controls how sparkling your drinking water is, from perfectly still to bursting with bubbles.

An LED indicator in the push button changes colour to let you see your chosen carbonation level at a glance – still, medium sparkling or sparkling – as well as telling you when the filter capacity has fallen below 10 % and will soon need to be changed. The water temperature can also be set to your personal taste, individually regulated to between 5 °C and 10 °C.



31 455 DC1
GROHE Blue Home
C-Spout



WITH PULL-OUT FUNCTION

Our new GROHE Blue Home taps now come with a pull-out mousseur head for ultimate functionality and flexibility. Select from three contemporary tap shapes with a pull-out head, each with a hygienic mousseur and two separate water ways, delivering both filtered and unfiltered water effortlessly.

Lead and nickel free

Pull-out mousseur

Hygienic mousseur with 2 outlets

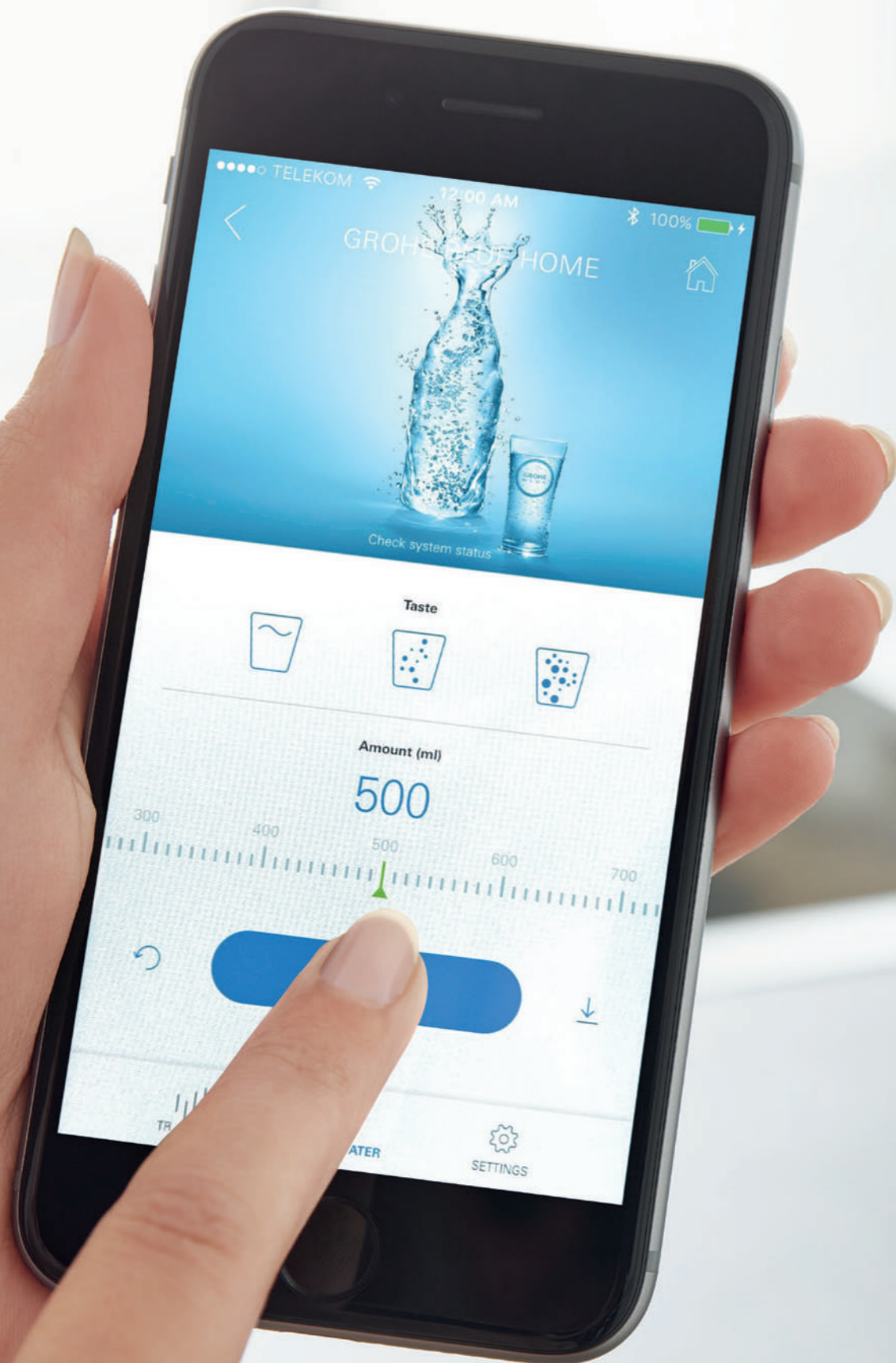

CONTROL VIA GROHE ONDUS APP

Control your GROHE Blue Home tap via smartphone app for total convenience. The GROHE Ondus app will not only let you know when the filter or CO₂ need replacing, but can reorder for you automatically. Use it to pour water and monitor your consumption via personal fitness apps.

- INTEGRATION OF THE COOLER TO THE LOCAL WLAN
- SET-UP OF SOFTWARE PARAMETERS
- AUTOMATIC REORDERING OF CONSUMABLES
- ALERTS WHEN CAPACITIES ARE LOW



System requirements

iPhone with iOS 9.0 or higher / smart phone with Android 4.3 or higher

Mobile devices and GROHE Ondus App are not included in delivery and have to be ordered separately via an authorised Apple store / store / iTunes or Google Play store.

The Bluetooth® word mark and logos are registered trademarks owned by Bluetooth SIG, Inc. and any use of such marks by Grohe AG is under license. Other trademarks and trade names are those of their respective owners. Apple, the Apple logo, iPod, iPod Touch, iPhone and iTunes are trademarks of Apple Inc., registered in the U.S. and other countries. Apple is not responsible for the function of this device or its compliance with safety and regulatory standards.

FIND OUT THE WAYS IN WHICH GROHE BLUE BRINGS BENEFITS TO YOUR HOME:

Imagine drinking water fresh from a mountain spring – life-affirming, thirst-quenching, and absolutely pure. Now imagine the same health-giving, untainted water flowing directly from your own kitchen tap. The GROHE Blue watersystem makes this a reality in your own home. It transforms ordinary tap water and filters it, leaving a taste as fresh and pure as nature intended.

Whatever your idea of perfect water refreshment – filtered, chilled, sparkling or all three – GROHE Blue brings it to you straight from the tap.



Separated inner water ways for unfiltered tap and filtered drinking water



Spout turnable by 150°

Hygienic mousseur with two outlets and optional pull-out

Forward rotating lever with knurled structure for better grip

Cartridge with GROHE SilkMove technology for normal tap water

TASTE

GROHE's filters remove impurities to give water a pure, fresh taste that even beats bottled water.

HEALTH & WELLNESS

Removing even small particles but leaving behind precious minerals, GROHE Blue makes it easy to embrace the health-giving properties of water.

CONVENIENCE

No more carrying heavy bottled water home.

SUSTAINABILITY

Kinder to the environment, with less waste on packaging and processing compared to bottled water.

**STILL, MEDIUM OR SPARKLING:
THE CHOICE IS ALL YOURS**

How sparkling do you like your water? It's all a matter of taste. GROHE Blue Home has a simple and intuitive mechanism that lets you carbonate your drinking water at the touch of a button. Deliciously cool filtered water, just the way that you – and all your family – like it.



Still waters run deep. If you prefer your water cool and still, nothing could be simpler: just push the top button. The LED lights up blue and your glass fills with pure refreshment.



Sparkling – but not too much? More of a medium sparkling? Coming right up. Press both buttons in sequence – the LED lights up turquoise – to produce a finely pearled stream of water.



Sparkling water, alive with bubbles. If that's your idea of thirst-quenching heaven, just press the lower button – the LED lights up green – for your perfect glass of water.

HEALTHIER LIVING FROM THE SOURCE

Water is the most precious and fascinating element on earth, the source of life itself, with proven benefits for our health, wellbeing and even appearance. The "Deutsche Gesellschaft für Ernährung" (German Nutrition Society) recommends that we drink at least two litres of water each day.

Many of us opt to buy bottled water, either because it tastes better than tap or because we believe it is healthier than tap water. However scientific analysis has proved that, due to strict regulations and controls on our drinking water supplies, tap water is at least as good as bottled.

Another reason people spend a small fortune on bottled water is the preference for sparkling water. Now GROHE Blue delivers all the benefits of bottled water, straight from the tap. It provides a great taste, plus the option of sparkling water too. This makes GROHE Blue the ultimate solution, not just for good health but for great taste as well.

CONVENIENCE ON TAP

Think for a moment about the energy and hassle it takes to keep a supply of bottled water on hand at home. You have to buy it from the supermarket, then lug it from the car to your house. Once there you have to find space to cool it or to store it out of sight. And when you've finished it you have to return or recycle the plastic bottles, before starting the whole process again.

By installing a GROHE Blue system in your kitchen you can say goodbye to the hassle and inconvenience of bottled water with no compromises on taste or health. Just turn the tap and enjoy an unrivalled refreshment experience. What could be easier than that?

WATER NEEDN'T COST THE EARTH

It takes an astonishing 7 litres of water to produce a single litre of bottled mineral water. Not to mention the energy used, CO₂ emissions created and the 1.5 million tons of plastic packaging used by the industry each year.

At GROHE we are always working to secure the future of water, our most precious natural resource. This is the driving force behind the development of such products as GROHE Blue, which help people manage their water and energy consumption with ease.





THE MAGIC IS IN THE FILTER

For our GROHE Blue system we have worked with BWT, Europe's leading filtered water professionals, to ensure that our system produces an unparalleled, refreshing drinking experience. Our standard high performance S-Size filter comes with every GROHE Blue Home starter set. It uses a five-step filtration process to remove even the smallest particles from tap water, while leaving behind all the important minerals that benefit your health.

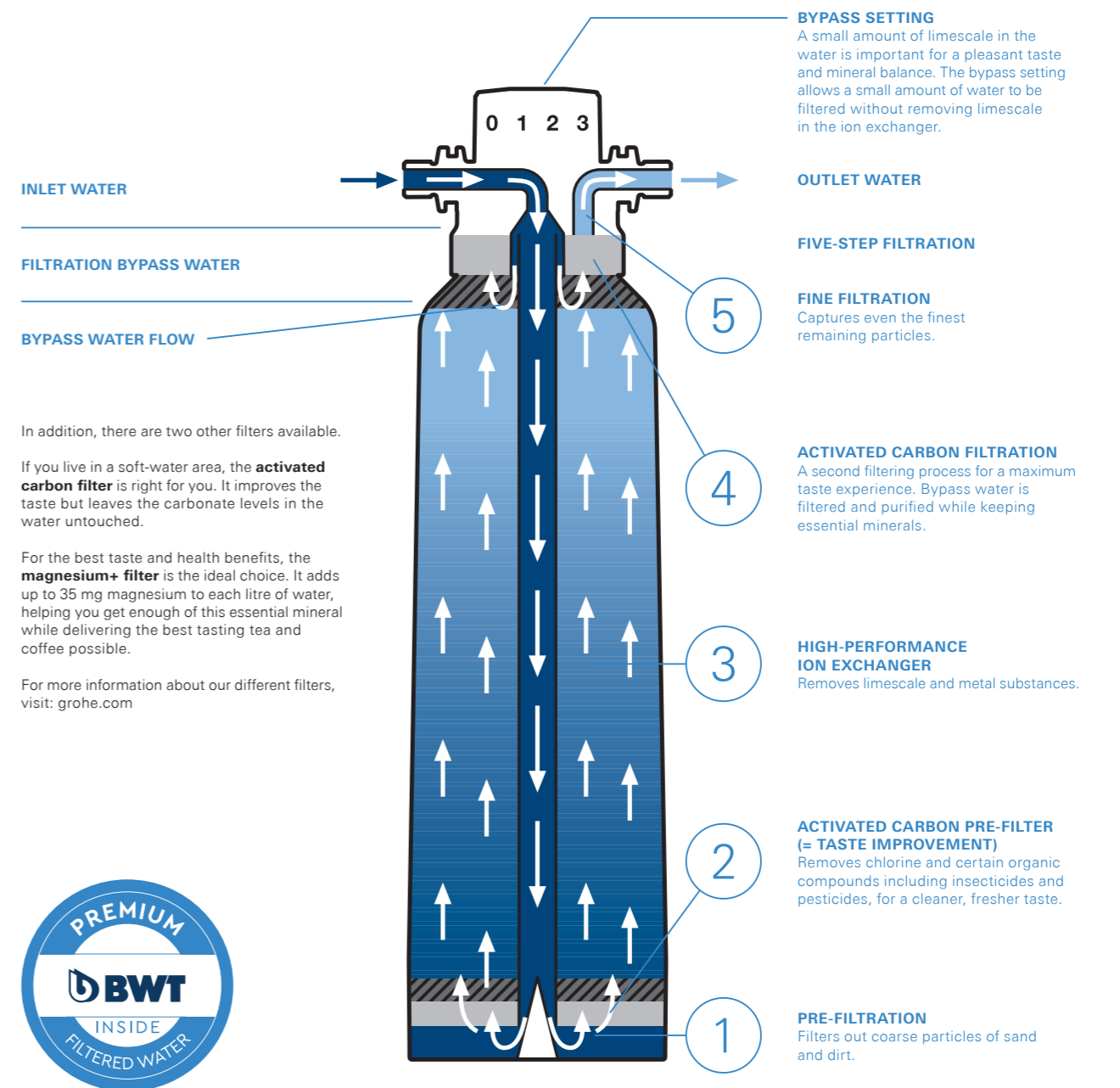

In addition, there are two other filters available.

If you live in a soft-water area, the **activated carbon filter** is right for you. It improves the taste but leaves the carbonate levels in the water untouched.

For the best taste and health benefits, the **magnesium+ filter** is the ideal choice. It adds up to 35 mg magnesium to each litre of water, helping you get enough of this essential mineral while delivering the best tasting tea and coffee possible.

For more information about our different filters, visit: grohe.com





● ●
31 539 000
 GROHE Blue Home
 L-Spout Starter Kit
 with pull-out mousseur



● ●
31 541 000
 GROHE Blue Home
 C-Spout Starter Kit
 with pull-out mousseur



● ●
31 543 000
 GROHE Blue Home
 U-Spout Starter Kit
 with pull-out mousseur



● ● ● ● ● ● ● ●
31 454 001
 GROHE Blue Home
 L-Spout Starter Kit



● ● ● ● ● ● ● ●
31 455 001
 GROHE Blue Home
 C-Spout Starter Kit



● ● ●
31 456 001
 GROHE Blue Home
 U-Spout Starter Kit

**EACH GROHE BLUE HOME
 STARTER KIT CONTAINS:**



● ● ● ● ● ● ● ●
31 498 001
 GROHE Blue Home
 Mono Starter Kit



GROHE BLUE HOME
 CARBONATOR



CO₂ BOTTLE 425 g



S-SIZE FILTER

- Colour options:**
- 000/001 | StarLight Chrome
 - DA1 | Warm Sunset
 - A01 | Hard Graphite
 - DC0/DC1 | SuperSteel
 - DL1 | Brushed Warm Sunset
 - AL1 | Brushed Hard Graphite





31 323 002
GROHE Blue Professional
C-Spout

GROHE BLUE PROFESSIONAL

BENEFITS AT A GLANCE

With the GROHE Blue watersystem your company can enjoy the benefits of filtered, chilled and sparkling water on tap. The GROHE Blue watersystem transforms ordinary tap water into filtered, fresh, perfect tasting drinking water, whenever you want it – 24 hours a day, 7 days a week.

TASTE & HYDRATION

GROHE's filters remove impurities to give water a pure, fresh taste that even beats bottled water.

COST & SPACE SAVING

GROHE Blue eliminates the cost and hassle of buying, transporting and storing bottled water. These savings will keep adding up, year after year.

COMFORT

Free and unlimited access to fresh and sparkling water will be valued by employees and increases motivation and productivity. Fast and easy preparation of cold- and hot drinks provides more time for the essentials.

SUSTAINABILITY

GROHE Blue reduces the carbon footprint – no more use of plastic bottles, less waste in production and lower CO₂ emissions than for bottled drinking water.



Separated inner waters for unfiltered tap- and filtered drinking water

Spout turnable by 150°

Hygienic mousseur with two outlets

Forward rotating lever with knurled structure for better grip

Cartridge with GROHE SilkMove technology for normal tap water

STILL, MEDIUM & SPARKLING WATER FROM ONE SOURCE

Still waters run deep. If you prefer your water cool and still, nothing could be simpler: just push the top button. The LED lights up blue and your glass fills with pure refreshment.

Sparkling water, alive with bubbles. If that's your idea of thirst-quenching heaven, just press the lower button – the LED lights up green – for your perfect glass of water.

Sparkling – but not too much? More of a medium sparkling? Coming right up. Press both buttons in sequence – the LED lights up turquoise – to produce a finely pearled stream of water.



GROHE ONDUS APP

The GROHE Ondus app allows you to integrate the GROHE Blue professional into your WLAN and thereby activate further advantages of the system. The app offers monitor functions for the remaining filters or CO₂ capacity, as well as allowing you to directly reorder when the capacity is running out. Also the software setting of the cooler can be easily made or adjusted via the app. In case of malfunctions, you will also be informed directly by push messages and will receive instructions for troubleshooting.



- Integration of the cooler to the local WLAN
- Set-up of software parameters
- Automatic reordering of consumables
- Alerts when capacities are low

System requirements
iPhone with iOS 9.0 or higher / smart phone with Android 4.3 or higher / WPA2 encrypted and password protected network, MAC address filters are not supported

Mobile devices and GROHE Ondus App are not included in delivery and have to be ordered separately via an authorised Apple store / store / iTunes or Google Play store.
The Bluetooth® word mark and logos are registered trademarks owned by Bluetooth SIG, Inc. and any use of such marks by Grohe AG is under license. Other trademarks and trade names are those of their respective owners.
Apple, the Apple logo, iPod, iPod Touch, iPhone and iTunes are trademarks of Apple Inc., registered in the U.S. and other countries. Apple is not responsible for the function of this device or its compliance with safety and regulatory standards.

GROHE BLUE CONTROL DESK

In addition to the GROHE Ondus app, the online control desk offers a clear overview of all the GROHE Blue systems connected to the app on one screen. Thanks to this feature, you can always keep track of the status of the GROHE Blue system, even in large office buildings and be informed in good time if a filter or a CO₂ bottle needs to be replaced.

- Live monitoring of all GROHE Blue systems on one screen, sorted by installation area and building
- Push notifications when filter or CO₂ capacity is low
- Re-ordering of consumables in webshop
- Stock management of consumables sorted by installation area and building
- Support with questions about the product

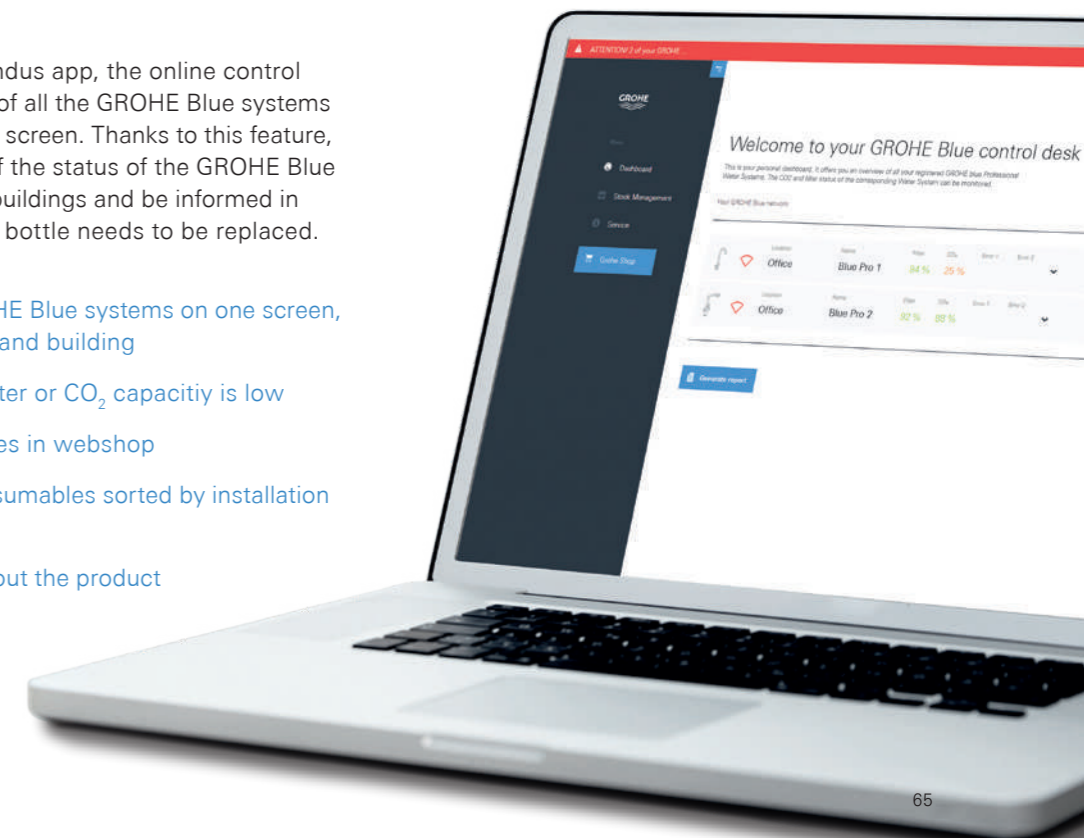



● ●
31 325 002
 GROHE Blue Professional
 C-Spout
 with pull-out mousseur



● ●
31 323 002
 GROHE Blue Professional
 C-Spout



● ●
31 326 002
 GROHE Blue Professional
 L-Spout
 with pull-out mousseur



● ●
31 347 003
 GROHE Blue Professional
 L-Spout



● ●
31 302 002
 GROHE Blue Professional Mono
 C-Spout

EACH GROHE BLUE PROFESSIONAL CONTAINS:



COOLER AND CARBONATOR BOX,
 FILTER HEAD, CO₂ PRESSURE REDUCER
 AND CLEANING ADAPTER

Filter, CO₂ bottle and cleaning cartridge
 have to be ordered separately according
 to your personal needs.

Colour options:
 ● 002/003 | StarLight Chrome ● DC2/DC3 | SuperSteel





30 382 000
GROHE Blue Pure
Minta Starter Set

GROHE BLUE PURE FILTER TAPS

PURER TASTE, PURE ENJOYMENT

Add great taste to your kitchen, effortlessly, with a GROHE Pure Blue Filter tap. GROHE Blue Filter tap technology turns tap water into great-tasting filtered drinking water, removing chlorine and other impurities that can impair taste. Separate internal water ways keep filtered and unfiltered water separate at all times. The GROHE filter fits easily under your sink, and the tap still offers all the usual functionality of a standard kitchen tap. Put pure, refreshing, filtered water at the heart of your kitchen with a GROHE Blue Pure tap.



● ●
30 382 000
 GROHE Blue Pure Minta
 Duo Filter tap
 with pull-out mousseur



30 383 000
 GROHE Blue Pure Eurosmart
 Duo Filter tap



30 385 000
 GROHE Blue Pure BauCurve
 Duo Filter tap



30 387 000
 GROHE Blue Pure
 Mono Filter tap

**EACH GROHE BLUE PURE
 FILTER TAP CONTAINS:**



ACTIVATED CARBON FILTER WITH FILTER HEAD
 AND FILTER EXCHANGE TIMER

Colour options:
 ● 000 | StarLight Chrome ● DC0 | SuperSteel



new



40 855 000
Extractible waste system,
30 cm, 2 x 15 litre waste bins,
swing door, floor erection

GROHE WASTE SYSTEMS

KITCHEN WASTE: SORTED

Streamline your kitchen with a GROHE waste system. As our awareness of waste and recycling grows, get your kitchen organized and say goodbye to your cumbersome freestanding bin. Instead a GROHE waste system fits neatly in the unit under your sink, sliding out effortlessly when you open the door. The waste system is available in models with one or two capacious waste compartments, and for base units of 60 cm and 90 cm, and can be installed alongside a GROHE watersystem. Free up floor space and enhance convenience with GROHE's new waste system.



40 855 000
Extractible waste system,
30 cm, 2 x 15 litre waste bins,
swing door, floor erection



40 980 000
Extractible waste system,
60 cm cabinet,
29 litre waste bin



40 981 000
Extractible waste system,
60 cm cabinet,
2 x 8 litre waste bins

Also available:

40 984 000
Retro-fit for extractible
metal cover



40 982 000
Extractible waste system,
90 cm cabinet,
29 + 11 litre waste bins



40 983 000
Extractible waste system,
90 cm cabinet,
2 x 8 + 11 litre waste bins

GROHE BLUE ACCESSORIES

Make the most of having delicious chilled, filtered water on tap with our range of GROHE Blue accessories. From replacement filters for all GROHE Blue taps, to CO₂ cartridges for GROHE Blue chilled and sparkling, plus our own range of branded GROHE water glasses and carafe, you'll find all you need to enjoy your seamless supply of cool, fresh drinking water in your home or office.



THE INDIVIDUAL CHOICE OF FILTRATION FOR PERFECT TASTE

For our GROHE Blue system we have worked with BWT, Europe's leading filtered water professionals, to ensure that our system produces an unparalleled, refreshing drinking experience. Our high-performance filters apply a 5-step filtration process to remove even the smallest particles from tap water, while leaving behind all the important minerals that benefit your health and provide pure taste.

For more information about our different filters, visit: shop.grohe.com

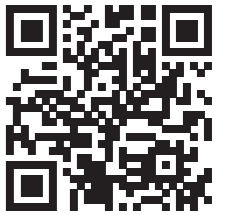

- + TASTE
- CHLORINE

ACTIVATED CARBON FILTER	
Product code:	40 547 001
Capacity @ < 9 KH:	3000 litres
Height:	234 mm
Radius:	88 mm

ACTIVATED CARBON FILTER

If you live in a soft-water area, the activated carbon filter is right for you. It improves the taste but leaves the carbonate levels in the water untouched.



- + TASTE
- + MAGNESIUM
- HEAVY METALS
- CHLORINE
- LIMESCALE

MAGNESIUM+ FILTER	
Product code:	40 691 001
Capacity @ 17 GH:	400 litres
Height:	315 mm
Radius:	88 mm

MAGNESIUM+ FILTER

For the best taste and health benefits, the magnesium+ filter is the ideal choice. It adds up to 35 mg magnesium to each litre of water, helping you get enough of this essential mineral while delivering the best tasting tea and coffee possible.



S-SIZE FILTER	
Product code:	40 404 001
Capacity @ 20 KH:	600 litres
Height:	234 mm
Radius:	88 mm



M-SIZE FILTER	
Product code:	40 430 001
Capacity @ 20 KH:	1500 litres
Height:	315 mm
Radius:	88 mm



L-SIZE FILTER	
Product code:	40 412 001
Capacity @ 20 KH:	2500 litres
Height:	350 mm
Radius:	103 mm

- + TASTE
- HEAVY METALS
- CHLORINE
- LIMESCALE

S-, M- & L-SIZE FILTER

The S-, M- & L-Size filters use a 5-step filtration process to remove even the slightest trace of impurities from the water – while retaining all the important minerals that benefit your health. The filter also fulfills another essential function: By filtering out limescale it ensures that the cooler can perform perfectly over its long lifetime.



40 405 000
GROHE Blue glass carafe
1000 ml



40 437 000
GROHE Blue glass
250 ml (6 pieces)



40 848 000 / 40 848 SD0
GROHE Blue drinking bottle,
tritan (BPA free), 500 ml
GROHE Blue drinking bottle,
stainless steel, 450 ml



40 422 000
GROHE Blue Starter Kit
CO₂ bottle 425 g (4 pieces)

Also available as:
40 687 000
GROHE Blue Refill Kit
CO₂ bottle 425 g (4 pieces)

40 920 000
GROHE Blue
CO₂ bottle 425 g (18 pieces)

+ 40 962 000
Adapter
for CO₂ bottle 425 g



40 423 000
GROHE Blue Starter Kit
CO₂ bottle 2 kg

Also available as:
40 424 000
GROHE Blue Refill Kit
CO₂ bottle 2 kg



40 434 001*
GROHE Blue cleaning cartridge

40 694 000
Adapter
for GROHE Blue cleaning cartridge
BWT filter head only to be used
in combination with 40 434 001.

* Required twice a year for GROHE Blue Professional and before first use according to EU DIN 6650





30 079 001
GROHE Red Duo
C-Spout, L-Size boiler

GROHE RED

THE NEW HOT SPOT IN YOUR KITCHEN

Never wait for the kettle to boil again. With the innovative GROHE Red system you can fill anything, from a mug to a large pot, with kettle-hot water in an instant – and all direct from your kitchen tap. With GROHE Red you still have your standard kitchen mixer, but separate push buttons provide kettle-hot water on tap.



30 079 001
GROHE Red Duo
C-Spout, L-Size boiler



TECHNOLOGY YOU CAN TRUST

Designed down to the last detail with a view to convenience, sustainability and safety, GROHE Red presents a range of intelligent and indispensable features.

SAFETY FIRST

Our first commitment is to your safety. That's why GROHE Red comes with a unique, failsafe child lock.

NO MORE WAITING

Kettle-hot water is always available at the push of a button, so waiting for the kettle or pot to boil is a thing of the past.

LESS WASTE

You only take the exact amount of hot water you need, so you save on water and energy consumption.

CLEAN, FRESH TASTE

Filtered water heated to 99 °C for an exceptional taste experience.

CLEAN YOUR WORKTOP

Filtered water heated to 99 °C. No need for the clutter of a kettle. GROHE Red fulfills all your water needs from a single tap.



Spout turnable by 150°

Separated inner water ways for normal tap and kettle-hot water

Forward rotating lever with knurled structure for better grip

Touch buttons with ChildLock safety for kettle-hot water

Cartridge with GROHE SilkMove technology for normal tap water

A SINGLE SIMPLE SOLUTION

TASTE THE DIFFERENCE

Use GROHE Red in combination with a GROHE Blue filter and get fresh just-filtered water served kettle-hot. Enjoy your tea and coffee with a great clean taste. The boiler where the water is heated is made of titanium, which does not impart any metallic taste to the water. It is also highly resistant to corrosion and limescale build-up, meaning a consistently great taste over the lifetime of the tap.

DECLUTTER YOUR KITCHEN

What busy kitchen doesn't need more worktop space? With GROHE Red you can clear the clutter of your kettle from the worktop and get both hot and cold mixed water plus kettle-hot water, all from the same tap. The system's compact boiler is designed to fit discreetly below the sink, leaving you more counter space and a cleaner, clearer-looking kitchen.

SAVE PRECIOUS TIME

Never wait for a pot of kettle-hot water or a much-needed cup of tea again. We all lead busy lives, and time spent waiting for water to boil all adds to the time spent on chores rather than relaxing. Whether it's cooking pasta, blanching vegetables or preparing a baby's bottle, GROHE Red cuts out the waiting time with kettle-hot water ready for you, the instant that you want it.

SAVE WATER, SAVE ENERGY

Think for a moment about how often you boil and reboil the kettle. How often do you actually use all the water? With GROHE Red you only take the hot water you need, saving precious water and time. In combination with the large GROHE Red boiler, which can replace a warm water outlet in the kitchen, the system saves even more water. The large GROHE Red boiler delivers the heated water for both kettle-hot water and also warm water for the sink mixer, instantly. No more wasted water while you wait for it to reach optimum temperature.

KETTLE-HOT WATER ON TAP

How many times a day do you fill and boil the kettle? From the first cup of tea in the morning to a late night pasta dinner, we boil up water countless times, often heating far more than we need. With GROHE Red you have water heated to 99 °C ready when you want it. It's convenient and saves water and time.





TECHNOLOGY THAT PUTS SAFETY FIRST

If there are children in your family, there can be few better reasons for banning the electric kettle for good. Unfortunately kettles continue to be the cause of many accidents in the kitchen. Tragically, the victims of these accidents are most often small children below the age of 5. It happens time and again: a child grabs a trailing flex or pulls a kettle of kettle-hot water over themselves. It just doesn't bear thinking about. In the UK, over 360 young children suffer severe scalding every year. That's one child every day – and every child is one too many.

When you choose GROHE Red you can be sure of choosing safety first. GROHE Red has passed the SGS-TÜV test, the independent body that confirms that the applicable safety requirements and quality standards have been met.



CHILDLOCK

Safety is paramount in a family kitchen. That's why GROHE Red taps are designed with a child lock that makes scalding practically impossible: for the kettle-hot water to flow, you must first unlock with the upper push button before the lower push button can be used.



GROHE RED TITANIUM BOILER

All boilers in our GROHE Red collection are made from titanium. Unlike stainless steel and copper, two metals traditionally used for boilers, titanium is highly resistant to corrosion and limescale build-up – ensuring perfect performance over a lifetime. It also guarantees that your water is free of any metallic taste.

GROHE RED

GROHE Red boiler* are cost and energy efficient – their improved design and insulation mean they achieve an A rating for their efficiency.

L-Size boiler for 5.5 l of kettle-hot water at once

M-Size boiler for 3 l of kettle-hot water at once

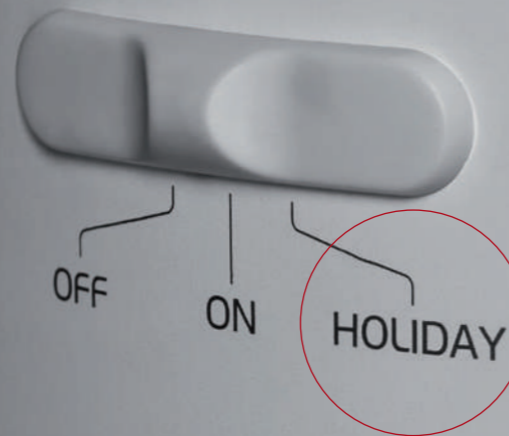

Going on holiday? Then simply switch the boiler to holiday mode, making sure any water is only heated to 60 °C for further energy savings.

* GROHE Red boiler M-Size:
Energy efficiency class A, heat losses max. 14 Wh
GROHE Red boiler L-Size:
Energy efficiency class A, heat losses max. 15,9 Wh



What is more, the titanium used to make the water tank means an incredibly durable boiler that won't corrode.



● ●
30 340 001
 GROHE Red Duo
 L-Spout, L-Size boiler

● ● ● ● ● ● ● ●
30 341 001
 GROHE Red Duo
 L-Spout, M-Size boiler



● ●
30 329 001
 GROHE Red Mono
 L-Spout, M-Size boiler

**EACH GROHE RED CONTAINS:
 BOILER (M- OR L-SIZE) & FILTERSET**



● ●
30 328 001
 GROHE Red Duo
 C-Spout, L-Size boiler

● ● ● ● ● ● ● ●
30 058 001
 GROHE Red Duo
 C-Spout, M-Size boiler



L-SIZE BOILER

M-SIZE BOILER



40 841 001
 GROHE Red mixing valve
 (additional equipment)



● ● ● ● ● ● ● ●
30 060 001
 GROHE Red Mono
 C-Spout, M-Size boiler



30 079 001
 GROHE Red Duo
 C-Spout, L-Size boiler

Colour options:

- 001 | StarLight Chrome
- DC1 | SuperSteel

- DA1 | Warm Sunset
- DL1 | Brushed Warm Sunset

- A01 | Hard Graphite
- AL1 | Brushed Hard Graphite





GROHE RED ACCESSORIES

Once you discover the superior taste that comes with GROHE Red, you won't want to do without it. And you don't have to: our stylish and practical GROHE Red thermo bottles don't just travel well, they keep your hot drinks hot for up to 8 hours. They also come equipped with a useful tea strainer that, like the bottle itself, is made from chic, hygienic stainless steel. Or enjoy a cup at home with a set of elegant GROHE Red tea glasses, made from heat-proof, dishwasher-safe glass. And our high-performance GROHE Red filters purify tap water through a five-stage process. The filtration removes even the smallest substances that might impair the taste of the water, while essential minerals are retained.



40 919 SDO
GROHE Red thermo bottle
incl. tea strainer
450 ml



40 432 000
GROHE Red tea glass
250 ml (4 pieces)



40 404 001
GROHE Blue S-Size filter
capacity 600 litre at 20° KH

40 430 001
GROHE Blue M-Size filter
capacity 1500 litre at 20° KH

40 412 001
GROHE Blue L-Size filter
capacity 2500 litre at 20° KH

40 547 001
GROHE Blue Active carbon filter
for regions with water hardness below 9° KH
capacity 3000 litre at < 9° KH

40 691 001
GROHE Blue Magnesium+ filter
with Magnesium and premium taste
capacity 400 litre at 17° KH



GROHE BRAND	2
GROHE KITCHEN FEATURES	9
GROHE WATERSYSTEMS	37
› GROHE PREMIUM LIFESTYLE COLLECTIONS	99
GROHE K7	102
GROHE SMARTCONTROL	106
GROHE ESSENCE	108
GROHE ESSENCE PROFESSIONAL	110
GROHE MINTA	114
GROHE MINTA TOUCH	120
GROHE ZEDRA	122
GROHE ZEDRA TOUCH	124
GROHE ATRIO	126
GROHE EUROCUBE	128
GROHE AMBI	130
GROHE PARKFIELD	132
GROHE PERFORMANCE LINES	137
GROHE KITCHEN SINKS	165
GROHE SOAP DISPENSERS	224

GROHE PREMIUM LIFESTYLE COLLECTIONS

At GROHE we understand that your kitchen is a reflection of you. It's more than just a space to cook and clean – it's where you express yourself, enjoy yourself and even stretch yourself. That's why we have created a range of products that allow your inner home chef to shine, with professional-grade functionality that won't let you down, tailored features to help you perform better and intelligent design that reflects your personal taste. With GROHE Premium Lifestyle Collections your kitchen can be as individual as you are.

DESIGN YOUR KITCHEN WITH COLOUR AT ITS HEART

Bring your kitchen to life with the new GROHE Colours. Inspired by world-wide colour trends, GROHE now offers ten colour finishes on a selection of kitchen taps and sinks, helping you design a space that is tailored to your individual tastes and needs. From warmer, organic shades like Warm Sunset to more urban, architectural finishes like Brushed Graphite, GROHE has the finish that is right for your scheme. Choose a colour with total confidence that your tap and sink will work together harmoniously in a Perfect Match. With GROHE Colours you have the freedom of choice to create a kitchen that has as much colour as the rest of your life.

DISCOVER THE COLOURS IN THE FOLLOWING LINES:

GROHE BLUE HOME & GROHE RED, K7, ZEDRA, ESSENCE, MINTA, ATRIO, K700 UNDERMOUNT AND ACCESSORIES



30 269 DL0
Sink mixer high spout

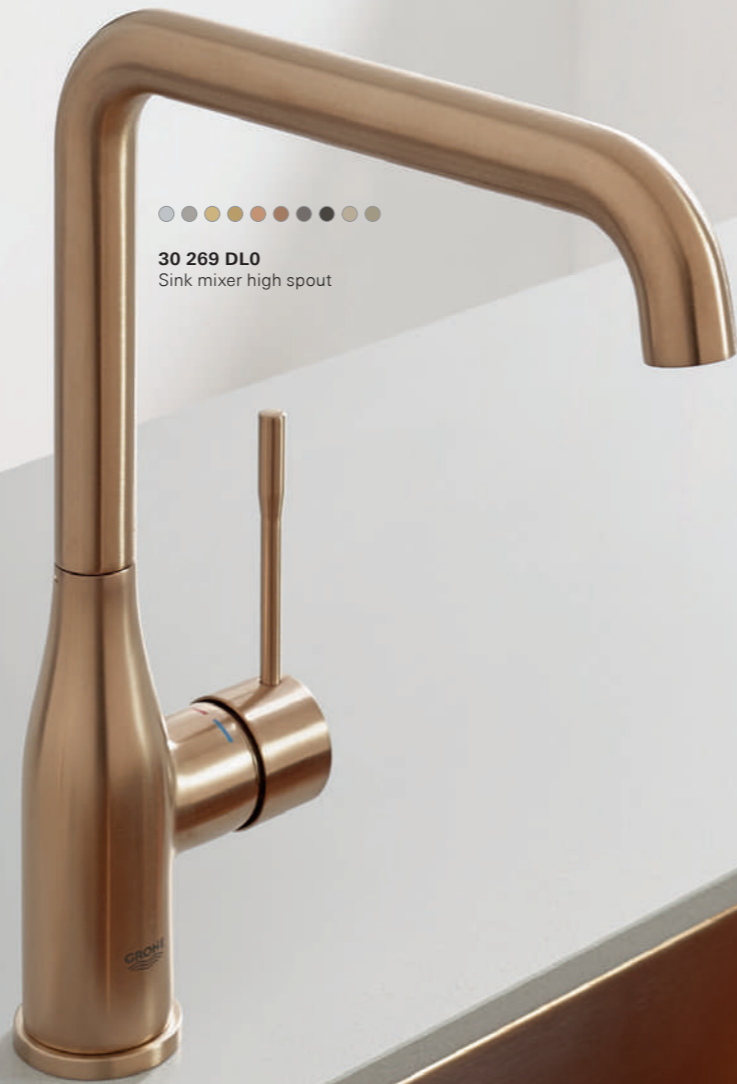

GROHE COLOURS

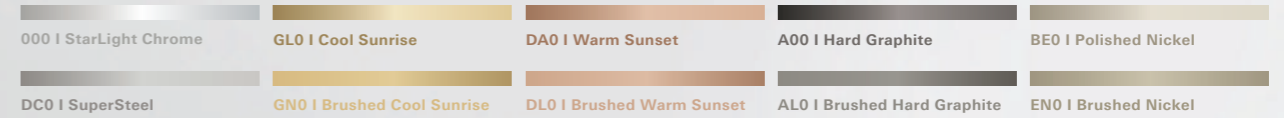

31 574 DL0
K700 Undermount
Brushed Warm Sunset
kitchen sink with 1 bowl



GROHE K7

Sleek and striking, the K7 range offers a professional-style kitchen tap in two spout heights, featuring a 360° turnable spring arm for maximum flexibility and a solid metal spray which allows for easy switching between mousseur and spray function. The K7 range also offers a swivel spout and variants with extractable dual spray and side sprays which guarantee the highest performance levels as well as stunning design. The K7 collection offers the ultimate flexibility for kitchens where performance really matters.



32 950 000
Professional
sink mixer





● ● ● ● ●
31 379 000
 Professional sink mixer



● ● ● ● ●
32 950 000
 Professional sink mixer



● ●
32 175 000
 Sink mixer



● ●
32 176 000
 Sink mixer
 with pull-out dual spray

Colour options:

- 000 | StarLight Chrome
- DC0 | SuperSteel

- A00 | Hard Graphite
- AL0 | Brushed Hard Graphite



GROHE SMARTCONTROL

Juggling kitchen tasks? Feel like you never have enough hands? The new SmartControl feature is here to make life easier. Instead of grappling with a lever it lets you switch the water flow on and off with just the touch of a button – meaning you can even use your elbow or wrist. Turn the button to control volume with ease, from an eco-flow to a powerful jet. To adjust the water temperature, turn the valve at the body gently to the left or right. The pull-out mousseur head gives you great flexibility for rinsing the sink or prepping veg. Available on three tap designs and in 11 desirable finishes, this innovation creates a sleek and streamlined silhouette and puts precise control at your fingertips.



31 615 000
Essence SmartControl
with pull-out mousseur



31 593 002
Zedra SmartControl
with pull-out mousseur



31 613 000
Minta SmartControl
with pull-out mousseur

Colour options:

- 000/002 | StarLight Chrome
- GL0 | Cool Sunrise
- DA0 | Warm Sunset
- A00 | Hard Graphite
- BE0 | Polished Nickel
- DC0/DC2 | SuperSteel
- GN0 | Brushed Cool Sunrise
- DL0 | Brushed Warm Sunset
- AL0 | Brushed Hard Graphite
- EN0 | Brushed Nickel



31 593 DC2
Zedra SmartControl
with pull-out mousseur





GROHE ESSENCE

Choose between two models, one with swivel spout and one with a solid metal pull-out spray, which offers easy switching between mousseur and spray. Add in a choice of two great-looking and durable finishes and you'll see that great design doesn't have to mean compromise on functionality.



30 269 000
Sink mixer high spout



30 270 000
Sink mixer high spout
with pull-out dual spray

Colour options:

- 000 | StarLight Chrome
- GL0 | Cool Sunrise
- DA0 | Warm Sunset
- A00 | Hard Graphite
- BE0 | Polished Nickel
- DC0 | SuperSteel
- GN0 | Brushed Cool Sunrise
- DL0 | Brushed Warm Sunset
- AL0 | Brushed Hard Graphite
- EN0 | Brushed Nickel



THE COLOURFUL WORLD OF ESSENCE PROFESSIONAL

Enhance your kitchen's performance with the sleek, architectural Essence Professional tap, designed to bring professional features and convenience to your scheme. From the 360 degree turnable spring arm to the effortless EasyDock M magnetic system for the dual-spray metal head, every detail has been designed with ease of use in mind. Featuring GrohFlexx technology, the hygienic santoprene hose is not only easy-to-clean but also comes in a choice of 10 colour finishes to harmonise with any kitchen.



30 294 GNO
Professional sink mixer
with dual spray

DESIGN PLUS
powered by: **ISH**





30 294 DC0 + 30 321 YR0
Professional sink mixer
with dual spray



30 294 000
Professional sink mixer
with dual spray



Colour options:

- 000 | StarLight Chrome
- DC0 | SuperSteel
- GL0 | Cool Sunrise
- GN0 | Brushed Cool Sunrise
- DA0 | Warm Sunset
- DL0 | Brushed Warm Sunset
- A00 | Hard Graphite
- AL0 | Brushed Hard Graphite
- BE0 | Polished Nickel
- EN0 | Brushed Nickel

Combine your Essence Professional with a choice of 10 hose colour finishes to make it the perfect fit for your kitchen.

Colour options (hose): Order an Essence Professional and add a hose in the colour of your choice (30 321 + colour code)

- MW0 | Sheer Marble
- DP0 | Pink
- XC0 | Dark Grey
- DU0 | Purple
- YF0 | Yellow
- GE0 | Green
- YR0 | Orange
- TY0 | Blue
- DG0 | Red
- HG0 | Dark Brown



GROHE MINTA

A stylish, minimal kitchen doesn't mean compromising on performance. The first thing you'll notice about GROHE's Minta tap is its sleek, clean silhouette, perfect for a contemporary kitchen. But what you'll enjoy day after day is its fantastic flexibility. With a pull-out spray head with dual spray control it makes cleaning, rinsing and prepping easy, letting you get the most out of your kitchen.



32 918 000
Sink mixer C-Spout
with pull-out mousseur

32 918 00E
with GROHE EcoJoy

32 511 000
for open water heater



32 917 000
Sink mixer C-Spout



32 321 002
Sink mixer C-Spout
with pull-out dual spray

Colour options:

- 000/002 | StarLight Chrome
- DC0/DC2 | SuperSteel
- KS0 | Velvet Black
- GN0/GN2 | Brushed Cool Sunrise
- DA0/DA2 | Warm Sunset
- DL0/DL2 | Brushed Warm Sunset
- A00/A02 | Hard Graphite
- AL0/AL2 | Brushed Hard Graphite



32 917 000
Sink mixer C-Spout



32 168 000
Sink mixer L-Spout
with pull-out mousseur



31 375 000
Sink mixer L-Spout



30 274 000
Sink mixer L-Spout
with pull-out dual spray



32 168 000
Sink mixer L-Spout
with pull-out mousseur

31 397 000
for open water heater



31 558 000
Sink mixer L-Spout
with pull-out dual spray
and stop valve

Colour options:

- 000 | StarLight Chrome
- DA0 | Warm Sunset
- A00 | Hard Graphite
- DC0 | SuperSteel
- DL0 | Brushed Warm Sunset
- AL0 | Brushed Hard Graphite
- GN0 | Brushed Cool Sunrise





● ●
32 067 000
 Sink mixer U-Spout
 with pull-out mousseur



● ● ● ● ● ● ● ●
32 322 002
 Sink mixer U-Spout
 with pull-out dual spray



● ● ● ● ● ● ● ●
32 488 000
 Sink mixer U-Spout



32 322 AL2
 Sink mixer U-Spout
 with pull-out dual spray

- Colour options:**
- 000/002 | StarLight Chrome
 - DA0/DA2 | Warm Sunset
 - A00/A02 | Hard Graphite
 - DC0/DC2 | SuperSteel
 - DL0/DL2 | Brushed Warm Sunset
 - AL0/AL2 | Brushed Hard Graphite





31 358 002
Electronic sink mixer C-Spout
with pull-out dual spray

GROHE MINTA TOUCH

Modern and minimal, the sensual curves and arcs of GROHE's Minta range will never go out of fashion, and sit perfectly in any contemporary kitchen. Now you can add the ultimate in cleanliness and convenience with the EasyTouch model. Letting you turn the water flow on and off with a touch of your arm, Minta Touch puts you in control.



● ●
31 358 002
Electronic sink mixer C-Spout
with pull-out dual spray



● ●
31 360 001
Electronic sink mixer L-Spout
with pull-out mousseur



Minta Touch has been approved and recommended for use by people with reduced mobility and the elderly. It has been tested and rated "good" by the Institute for Gerontotechnik for Barrier Free Building, due to its one-touch operating technology and ergonomic design.

Colour options:

- 001/002 | StarLight Chrome
- DC1/DC2 | SuperSteel



GROHE ZEDRA

The reinvention of a legend brings design flair and innovative operation to your kitchen – the new GROHE Zedra. With an elegantly fluted body the Zedra offers intuitive, tactile operation and great features such as lead and nickle free water flow. The pull-out spray is ideal for rinsing veg or the sink itself – you can select from three spray types according to the job in hand – while water consumption is reduced by up to 70 % without compromising performance. When finished it retracts easily into place thanks to the Magnetic Docking system. The range has a model to suit every need, from a SmartControl version to a pillar tap with filter. Available in two finishes, this sleek, sophisticated tap puts you in control.



● ●
32 294 002
Sink mixer
with pull-out triple spray



● ●
32 553 002
Sink mixer
with pull-out dual spray



30 026 002
Pillar tap
with S-Size filter

Colour options:
● 002 | StarLight Chrome ● DC2 | SuperSteel



32 294 002
Sink mixer
with pull-out triple spray



GROHE ZEDRA TOUCH

Put the sweeping, sensual power of water at the centre of your kitchen with the Zedra Touch. Zedra's distinctive fluted swivel spout and beautifully tactile lever combine ergonomic design with visual flair. The addition of GROHE's EasyTouch technology enables you to also control the water flow with just one touch. Choose your Touch function in the standard-version with an integrated mixing unit or upgrade with an under-sink Grohtherm Micro thermostat for perfectly controlled warm water and no danger of scalding.



30 219 002
Electronic sink mixer
with pull-out dual spray

Colour options:

● 002 | StarLight Chrome

● DC2 | SuperSteel



GROHE ATRIO

The pared back, carefully considered lines of GROHE Atrio create a modern icon for the kitchen. With a slim brass body and sculptural cross handles, it will add architectural style to your scheme. Its high, swivel spout leaves lots of space for filling large pots and creates a more flexible working area, with smooth, precise volume and flow control guaranteed. Available in three durable and desirable finishes – Chrome, SuperSteel and Brushed Hard Graphite – this elegantly minimalist design is a future kitchen classic.



30 362 000
Two handle sink mixer
C-Spout

Colour options:
 ● 000 | StarLight Chrome ● DC0 | SuperSteel ● AL0 | Brushed Hard Graphite



30 362 AL0
Two handle sink mixer
C-Spout





31 395 DC0
Professional sink mixer
with dual spray

GROHE EUROCUBE

Make a statement with GROHE's Cubist masterpiece. The Eurocube's strong lines and solid, architectural shape is perfect for modern kitchens where design is at the forefront. From the lever's cut-out detailing to the new professional-grade features, this is a tap for those who are both style conscious and serious about their cooking.



31 255 000
Sink mixer

31 395 000
Professional sink mixer
with dual spray

Colour options:

- 000 | StarLight Chrome
- DC0 | SuperSteel



GROHE **AMBI**

Opt for a contemporary classic with the Ambi tap range. Advanced engineering meets subtle design options in Ambi's two models, both with the comfortable functionality of twin forward-rotating levers.



30 189 000
Contemporary
Two handle sink mixer



30 190 000
Cosmopolitan
Two handle sink mixer



30 190 000
Cosmopolitan
Two handle sink mixer



GROHE PARKFIELD

Solid and organic, the Parkfield mixer is perfect for hands-on chefs. It features a single tactile lever controlling the flow and a solid pull-out head that lets you switch quickly between two spray patterns. A SpeedClean nozzle feature and taller spout for more comfort, Parkfield offers a practical, powerful solution for all kitchens.



30 215 001
Sink mixer
with pull-out dual spray

Colour options:

● 001 | StarLight Chrome

● DC1 | SuperSteel





GROHE BRAND	2
GROHE KITCHEN FEATURES	9
GROHE WATERSYSTEMS	37
GROHE PREMIUM LIFESTYLE COLLECTIONS	99
› GROHE PERFORMANCE LINES	137
GROHE EURODISC COSMOPOLITAN	138
GROHE CONCETTO	140
GROHE EUROSTYLE COSMOPOLITAN	144
GROHE EUROSMART COSMOPOLITAN	148
GROHE EUROSMART	152
GROHE BAULINES	158
GROHE KITCHEN SINKS	165
GROHE SOAP DISPENSERS	224

GROHE PERFORMANCE LINES

Get the most out of your busy kitchen with GROHE's Performance Lines. Created to offer a huge range of practical features to make any kitchen easier, safer and more enjoyable to use, you are bound to find the perfect solution. With a variety of modern designs, plus versatile height and installation options, GROHE Performance Lines offer great value and functionality that will enhance your life every day.

GROHE EURODISC COSMOPOLITAN

Proving that intensely practical design can work in balance with attractive, modern styling, Eurodisc Cosmopolitan has been created to be the perfect solution for any kitchen setting. You'll love the variety on offer, making for easy installation and even easier use, while a tapering spout and slightly angled lever add to the sleek effect.



33 770 002
Sink mixer medium spout



32 257 002
Sink mixer medium spout
with pull-out dual spray



33 772 002
Sink mixer
wall-mounted



33 770 002
Sink mixer medium spout



31 491 DC0
Professional sink mixer
with dual spray

GROHE CONCETTO

Making distinctive design accessible for all, Concetto is ideal for kitchens where style and practicality have to go hand-in-hand. Design-lovers will adore the distinctive silhouette based on a series of cylinders, while the hard-working cook will appreciate the finger-tip control and great performance.



31 491 000
Professional sink mixer
with dual spray

Colour options:

- 000 | StarLight Chrome
- DC0 | SuperSteel





● ●
31 483 002
Sink mixer high spout
with pull-out dual spray



● ●
32 661 003
Sink mixer high spout



● ●
32 663 003
Sink mixer high spout
with pull-out mousseur

31 132 001
for open water heater

32 666 001
with stop valve

31 212 001
for open water heater



● ●
31 128 001
Sink mixer medium spout



● ●
31 129 001
Sink mixer medium spout
with pull-out mousseur



● ●
30 273 001
Sink mixer medium spout
with pull-out dual spray

31 210 001
for pre-window

31 214 001
for open water heater



32 659 001
Sink mixer low spout



32 667 001
Sink mixer
wall-mounted

Colour options:
● 001/002/003 | StarLight Chrome ● DC1/DC2/DC3 | SuperSteel





31 124 002
Sink mixer medium spout

GROHE EUROSTYLE COSMOPOLITAN

Great design and great performance are at your fingertips with the Eurostyle Cosmopolitan range. From the appealing lozenge-shape of the lever to a choice of dynamic spout shapes, Eurostyle Cosmopolitan has a solution for every type of kitchen environment.



33 975 004
Sink mixer high spout

31 127 002
for open water heater



31 126 004
Sink mixer high spout
with pull-out mousseur



31 482 003
Sink mixer high spout
with pull-out dual spray



30 221 002
Sink mixer high spout



31 124 002
Sink mixer medium spout

31 159 002
for pre-window



33 977 002
Sink mixer low spout

33 984 002
for open water heater



33 982 002
Sink mixer
wall-mounted





32 843 002
Sink mixer high spout

GROHE EUROSMART COSMOPOLITAN

Simplicity is at the heart of good design and functionality. That's why GROHE's Eurosmart Cosmopolitan range focuses on the essentials to create a collection with durable details and architectural edge.

Put ergonomics and architectural lines centre-stage in your kitchen with Eurosmart Cosmopolitan. With this range simplicity doesn't mean lack of choice – from the three height options to the user-friendly swivel spout or an extractable mousseur spray you'll find a solution to suit you and your own contemporary kitchen.



● ●
32 843 002
 Sink mixer high spout
31 180 000
 for open water heater



31 481 001
 Sink mixer high spout
 with pull-out dual spray



● ●
30 193 000
 Sink mixer medium spout
30 194 000
 for open water heater



30 195 000
 Sink mixer medium spout
 with stop valve



32 842 000
 Sink mixer low spout
31 179 000
 for open water heater

31 170 000
 Sink mixer low spout
 for pre-window

31 161 000
 Sink mixer low spout
 with stop valve

Colour options:
 ● 000/001/002 | StarLight Chrome ● DC0/DC2 | SuperSteel





30 305 000
Sink mixer low spout
with pull-out dual spray

GROHE EUROSMART

Create a kitchen that the whole family can take pleasure in with the new GROHE Eurosmart. Effortless control, unrivalled performance and temperature-safe operation combine in a sleek contemporary design. The solid cylindrical body, the elegant curve of the spout – the new Eurosmart range looks great while offering huge versatility. In a variety of two heights, with a useful swivel spout and the option of our water-saving GROHE EcoJoy feature or the energy-saving cold-start cartridge GROHE SilkMove ES, Eurosmart is bound to fit in with your busy family kitchen.

Take your kitchen to the next level with the Eurosmart pull-out kitchen tap. Equipped with the basic features of Eurosmart and adding a functional pull-out dual spray, Eurosmart pull-out will help you do your daily kitchen tasks with just tip of your finger. The pull-out dual spray gives you a greater operating radius of the tap while offering easy switching between two sprays. The EasyDock mechanism guarantees easy retraction and smooth docking for your spray head, every time. Eurosmart pull-out comes with a shiny chrome surface or a matt SuperSteel finish to fit your kitchen perfectly.

Integrated temperature limiter

EasyDock

Lead and nickel free

Pull-out dual spray

SpeedClean mousseur

No scalding on hot surfaces thanks to 100 % GROHE CoolTouch

EasyExchange
The aerator is easy to install and de-install using just a coin

35 mm cartridge with integrated temperature limiter

MODERN SHAPE & SMART TECHNOLOGY



GROHE cartridge with integrated temperature limiter. Can be individually set to the desired maximum water temperature.



● ●
33 281 002
Sink mixer low spout

30 260 002
Sink mixer low spout
with GROHE SilkMove ES



● ●
30 305 000
Sink mixer low spout
with pull-out dual spray



32 482 002
Sink mixer
wall-mounted



31 509 002
Sink mixer
wall-mounted
with 150 mm projection

31 391 002
with 217 mm projection

32 224 002
with 277 mm projection



31 556 002
Sink mixer L-Spout
with stop valve



31 557 002
Sink mixer U-Spout
with stop valve



● ●
33 202 002
Sink mixer C-Spout

33 490 002
Sink mixer C-Spout
with GROHE SilkMove ES
with stop valve

Colour options:
● 000/002 | StarLight Chrome ● DC0/DC2 | SuperSteel



31 556 002
Sink mixer L-Spout
with stop valve

new

GROHE **BAULINES**

Stunning simplicity defines the GROHE Bau. The cylindrical spout creates a lightness of design ideal for architectural schemes without compromising performance. The comfortable height and smooth turn mechanism ensures vital flexibility. The range variety offers a well-suited tap for your classical, contemporary or cosmopolitan kitchen.



31 693 001
GROHE BauEdge
Sink mixer medium spout

new



31 538 001
GROHE BauFlow
Sink mixer high spout



31 590 000
GROHE BauEdge
Sink mixer high spout



31 367 001
GROHE BauEdge
Sink mixer high spout



31 368 001
GROHE BauLoop
Sink mixer high spout



31 535 001
GROHE BauClassic
Sink mixer high spout



31 536 001
GROHE BauCurve
Sink mixer high spout



31 538 001
GROHE BauFlow
Sink mixer high spout



new



31 682 000
GROHE BauEdge
Sink mixer low spout



31 715 000
GROHE BauCurve
Sink mixer medium spout



31 688 000
GROHE BauFlow
Sink mixer medium spout



31 693 000
GROHE BauEdge
Sink mixer medium spout

31 694 000
GROHE BauEdge NR
Sink mixer medium spout



31 706 000
GROHE BauLoop
Sink mixer medium spout



31 696 000
GROHE BauEdge
Sink mixer medium spout
with stop valve



31 713 000
GROHE BauLoop
Sink mixer medium spout
with stop valve



31 680 000
GROHE BauEco
Sink mixer low spout



31 682 000
GROHE BauEdge
Sink mixer low spout



GROHE BRAND	2
GROHE KITCHEN FEATURES	9
GROHE WATERSYSTEMS	37
GROHE PREMIUM LIFESTYLE COLLECTIONS	99
GROHE PERFORMANCE LINES	137
› GROHE KITCHEN SINKS	165
GROHE STAINLESS STEEL SINKS	172
GROHE K1000 SERIES	174
GROHE K800 SERIES	176
GROHE K700 UNDERMOUNT SERIES	178
GROHE K700 SERIES	180
GROHE K500 SERIES	184
GROHE K400+ SERIES	186
GROHE K400 SERIES	190
GROHE K200 SERIES	194
GROHE COMPOSITE SINKS	200
GROHE K700 UNDERMOUNT SERIES	202
GROHE K700 SERIES	206
GROHE K500 SERIES	210
GROHE K400 SERIES	214
GROHE K200 SERIES	218
GROHE SOAP DISPENSERS	224

GROHE

KITCHEN SINKS

Add up how much time you spend at your kitchen sink. Filling pots, preparing veg, washing up after a big meal. It's a place you will stop at countless times each day, so why not choose a sink that exceeds your needs in terms of quality, design and features?

GROHE sinks have been designed to fit every type of kitchen scheme, with a range of innovative, modern designs perfect for your space. You can choose between a sleek, hardwearing stainless steel model or a super-durable composite available in two contemporary colours. You will find compact models with integrated drainers, large double sinks for when you need to spread out, and chic built-in sinks that fit flush to your worktop.

With features like the GROHE QuickFix system and reversible designs as standard, you can have your new GROHE sink installed in minutes with no fuss or hassle. We are also confident that you will love the special features on offer, like the automatic waste that means never plunging your hand into dirty water again. Thanks to GROHE Whisper technology you can even be sure that this will be your quietest sink ever – for composite sinks the material itself reduces the noise from water flow and for GROHE stainless steel sinks special integrated insulation achieves the same effect. With a sink from GROHE you'll notice the difference, making every time you use your sink less of a chore.

SINK AND TAP IN PERFECT HARMONY

Everything about the GROHE range of sinks has been designed for a perfect fit – with your tap, with your kitchen, with your lifestyle. All of the sinks have been designed to be paired effortlessly with our kitchen taps and watersystems, both in terms of design and practicality, with comfortable proportions and no splashing.

Whatever the design of your kitchen you will find a GROHE sink that complements it beautifully. You can choose between a sleek, hardwearing stainless steel model or a super-durable composite available in two contemporary colours, both perfectly matched to new GROHE Colour options. The range includes topmount models, flush-mounted, under-mounted and flat-edge models, with numerous different designs, from timeless to crisply minimal. Whether you are kitting out a compact kitchen or looking for a centrepiece sink for your island unit, GROHE has a model that is just right, and at a price point that suits.

To make it even easier to pick the right sink and tap for you, we've also created four pre-packed sink and tap bundles, so you can buy your ideal sink and tap together, hassle-free. Encompassing our most popular lines, you can select a Bau, Eurosmart, Concetto or Minta sink bundle, making design, purchase and installation an even smoother, swifter process.



QUALITY THAT LASTS A LIFETIME

GROHE's reputation for quality of course extends to every sink in our range. With steel thicknesses ranging from 0.6 mm on the entry price segment to 1 mm on the premium ranges, each stainless steel sink uses steel above industry standards, and our patented brushing process creates a super-smooth surface that is easy to clean. Our composite sinks produced in a special computer-controlled casting process use 76 % quartz mixed with acrylic resin for a super hardwearing material offering superlative durability and function, with smooth pore-free surface that is resistant to heat, dents scratches and stains, hygienic and easy to clean. For additional reassurance, each GROHE sink comes with a five year warranty, just like our taps.



FEEL THE BENEFITS INNOVATIVE FEATURES, FINISHES AND FUNCTIONS

We can't claim to make washing up a joy, but thanks to the smart, useful features of every GROHE sink, we certainly believe that we can make your sink somewhere you are happy to spend some time. With a GROHE sink, cleaning is easier, draining the bowl can be done remotely, and even the sound of the water running is minimised. Just select your ideal size and style – installation is effortless and the benefits speak for themselves.

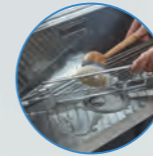

Spacious bowls

All GROHE kitchen sinks feature spacious bowls meaning you have lots of room to maneuver and enough space for washing large pots with ease. Thanks to our innovative manufacturing technique, all of our stainless steel sinks offer a generous depth of min. 16 cm while the innovative computerized casting technique allows our composite sinks a generous depth of even at least 20 cm.



Pre-punched tap holes

Many models come with pre-punched tap holes, meaning no additional tools are required and some sinks are reversible and can be installed as either left- or right-handed option.

Overflow

The overflow, available on all GROHE sinks, avoids any spillage of water in case the taps are inadvertently left open. The perimetric solution available on some models improves the look, thanks to its squared-out and essential shape.



Waste fitting with remote control

GROHE sinks are equipped with a 3.5" waste fitting and practical strainer plug that prevents solids and leftovers from flowing away with the waste water. The steel cap available on some models adds elegance to the bowl and hides any residue collected in the underlying basket.



Siphon included

For a quick and hassle-free installation each sink comes with an under-sink siphon complementing the scope of delivery and guaranteeing an ALL IN ONE solution.

Water drainage

Drainage from the bowl's base and drainers is an important feature, always well cared for on GROHE sinks. In the squared-out, flat-bottomed sinks, good drainage is ensured by the elegant diamond-shaped creases that make the water flow away more easily.

GROHE STAINLESS STEEL SINKS

INNOVATIVE FEATURES, FINISHES AND MOUNTING TYPES

Customize your kitchen space by choosing the perfect GROHE sink for you. Our K-series range of stainless steel sinks covers every size, configuration and price point, so you're sure to find your perfect fit. The range includes 1, 1.5 or 2 bowl options. Various mounting types from built-in to undermount are available for your individual taste. Make it your very own central kitchen hub with our accessories – perfectly matching our sinks for your ultimate comfort.

We are also confident that you will love the special features on offer, from the noise-reducing GROHE Whisper insulation to the automatic waste that means never plunging your hand into dirty water again. With a sink from GROHE you'll notice the difference, making every time you use your sink less of a chore.

FINISHES

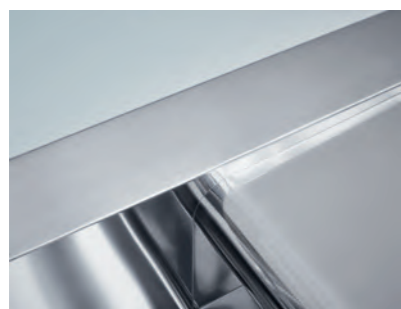

AISI 304

On every sink model GROHE uses the AISI 304 stainless steel, exceeding the quality standard of the industry. Thanks to its high percentages of chrome and nickel it contains, AISI 304 steel gives a particularly bright finish and makes the products enduring against rust and corrosion.

AISI 316 (marine steel)

With AISI 316 available on the K400+ series, GROHE offers a durable solution even for regions with salty, rust-causing climate. Also known as the "marine steel", AISI 316 is mainly used in the shipbuilding or chemical industries. Famous for its high percentages of chrome, nickel and molybdenum, the steel is extremely resistant to rust and corrosion and even acids or chlorine.

Patented brushing technique (GROHE satin finish)

The K200 – K1000 series are treated with special vegetable fibres (Tampico) that give the sinks the characteristic extrafine satin finish that is highly elegant and functional. GROHE's patented brushing technique creates a stainless steel surface that is smoother and less porous than many other brands, making cleaning your sinks easier and significantly enhancing its durability.

INNOVATIVE FEATURES



GROHE StarLight

All GROHE sinks use stainless steel graded above the industry average, so you can be confident of their quality and durability. Our innovative brushing technique means that the sparkling steel surface is ultra smooth for easier cleaning.



GROHE QuickFix

Install your sink swiftly and easily thanks to the GROHE QuickFix system (kit supplied). With two pre-punched tap holes most of our sinks are easily reversible, giving you the flexibility you need for any design scheme.



GROHE Whisper

Shhh! A special insulation on the underside of the sink means that noise from running water and handling pots and pans is reduced to a minimum.

MOUNTING TYPES



Topmount

Traditional built-in with a vertical 8 mm edge.



Undermount

Sleek and contemporary, ideal for installation under the worktop.



Flat-edge

An original edge with an inclined 3 mm high profile, matching an extreme elegance with the ease of installation.



Flush-mount

The product is sunk 1,5 mm deep recess making it perfectly flush with the worktop. Alternatively, it can be installed on the worktop.

GROHE STAINLESS STEEL **K1000 SERIES**

A superior sink designed for the demands of contemporary kitchens, the K1000 features a welded design with a diamond-shaped bottom, as well as a generous draining area. Its architectural style is matched by useful features like an included siphon and automatic waste fitting. It can be flush-mounted or built-in.



31 581 SD1
K1000
Stainless steel kitchen sink
with 1 bowl



31 582 SD1
K1000
Stainless steel kitchen sink
with 1 bowl



GROHE STAINLESS STEEL K800 SERIES

Select a premium sink for your kitchen, in terms of both design and durability, with the K800. Select from 1 or 2 bowls, flush-mounted or built-in, and enjoy the added benefits of its space-saving siphon and automatic waste fitting with stylish waste basket cover.



31 583 SD1
K800
Stainless steel kitchen sink
with 1 bowl



31 585 SD1
K800
Stainless steel kitchen sink
with 2 bowls



31 584 SD1
K800
Stainless steel kitchen sink
with 1 bowl



31 586 SD1
K800
Stainless steel kitchen sink
with 1 bowl



GROHE STAINLESS STEEL K700 UNDERMOUNT SERIES

Get the uncluttered, architectural look with the K700 under-mounted sink. With a deeper bowl and soft edges, it is designed to fit under your counter for a seamless, modern finish. Available in 1 or 1.5 bowl versions with bigger bowl on the left or right side.



● ● ● ● ●
31 574 SD0
K700 Undermount
Stainless steel kitchen sink
with 1 bowl



31 576 SD1
K700 Undermount
Stainless steel kitchen sink
with 1.5 bowls



31 575 SD1
K700 Undermount
Stainless steel kitchen sink
with 1.5 bowls



31 577 SD1
K700 Undermount
Stainless steel kitchen sink
with 1.5 bowls

Colour options:
● DC0 | SuperSteel ● GN0 | Brushed Cool Sunrise ● DL0 | Brushed Warm Sunset ● AL0 | Brushed Hard Graphite



GROHE STAINLESS STEEL K700 SERIES

Perfect for modern, minimalist kitchens, the K700 cubistic sink offers a deeper, larger bowl with radiant edges and a diamond-shaped bottom. Ideal for larger kitchens, the sink is available for standard built-in installation or flush-mounting and three different sizes.





31 726 SD0
K700
Stainless steel kitchen sink
with 1 bowl



31 578 SD1
K700
Stainless steel kitchen sink
with 1 bowl



31 580 SD1
K700
Stainless steel kitchen sink
with 1 bowl



GROHE STAINLESS STEEL K500 SERIES

In tough stainless steel, with welded finish for added durability, the K500 sink offers contemporary design chic with practical features. Choose a 1 or 1.5 bowl (reversible) model with drainer and automatic waste fitting.



31 563 SD1
K500
Stainless steel kitchen sink
with 1 bowl and reversible drainer



31 571 SD1
K500
Stainless steel kitchen sink
with 1 bowl and reversible drainer



31 572 SD1
K500
Stainless steel kitchen sink
with 1.5 bowls and reversible drainer



31 588 SD1
K500
Stainless steel kitchen sink
with 2 bowls and reversible drainer



31 573 SD1
Minta Sink Bundle
consisting of:
Stainless steel kitchen sink K500
Single-lever sink mixer Minta
with pull-out mousseur



GROHE STAINLESS STEEL **K400+ SERIES**

With the K400+ sink that uses AISI 316 grade stainless steel, GROHE offers an additional solution even for regions with a salty, rust-causing climate. The K400+ series comes with 1 or 1.5 bowl options. Both models are reversible and offer a 4 mm flat edge detail for a sleeker finish.



31 129 DC1
Concetto
Sink mixer medium spout
with pull-out mousseur

31 569 SD0
K400+
Stainless steel kitchen sink
with 1.5 bowls and reversible drainer



AISI 316

With AISI 316 available on the K400+ series, GROHE offers a durable solution even for regions with salty, rust-causing climate. Also known as the “marine steel”, AISI 316 is mainly used in the shipbuilding or chemical industries as it is famous for its high percentages of chrome, nickel and molybdenum which make the steel extremely resistant to rust and corrosion and even acids or chlorine.



31 568 SDO
K400+
Stainless steel kitchen sink
with 1 bowl and reversible drainer



31 569 SDO
K400+
Stainless steel kitchen sink
with 1.5 bowls and reversible drainer



GROHE STAINLESS STEEL K400 SERIES

Give your kitchen a design-orientated edge with the K400 sinks. Sturdy and practical, but with distinctive design flair, the K400 sinks come in 1, 1.5 or 2 bowl options, with drainer. All models are reversible and come with standard built-in edge and remote waste.



31 570 SDO
Concetto Sink Bundle



31 566 SD0
K400
Stainless steel kitchen sink
with 1 bowl and reversible drainer



31 570 SD0
Concetto Sink Bundle
consisting of:
Stainless steel kitchen sink K400
Single-lever sink mixer Concetto
with pull-out mousseur



31 567 SD0
K400
Stainless steel kitchen sink
with 1.5 bowls and reversible drainer



31 587 SD0
K400
Stainless steel kitchen sink
with 2 bowls and reversible drainer



GROHE STAINLESS STEEL K200 SERIES

Versatile design that is a perfect fit for every home, K200 sinks are a durable, practical option for busy kitchens. With a 1 or 1.5 bowl, this model is a flexible, functional entry-level option suitable for any kitchen style. It is also available in a square model with rounded edges, and a round version.



31 719 SDO
K200
Stainless steel kitchen sink
with 1 bowl



31 552 SD1
K200
Stainless steel kitchen sink
with 1 bowl and reversible drainer



31 565 SD1
Eurosmart Sink Bundle
consisting of:
Stainless steel kitchen sink K200
Single-lever sink mixer Eurosmart
with swivel spout



31 564 SD1
K200
Stainless steel kitchen sink
with 1.5 bowls and reversible drainer



31 719 SD0
K200
Stainless steel kitchen sink
with 1 bowl



31 562 SD1
Bau Sink Bundle
consisting of:
Stainless steel kitchen sink K200
Single-lever sink mixer BauEdge
with swivel spout



31 720 SD0
K200
Stainless steel kitchen sink
with 1 bowl





GROHE COMPOSITE SINKS

INNOVATIVE FEATURES, FINISHES AND MOUNTING TYPES

Customize your kitchen space by choosing the ideal GROHE sink for you. Our K-series range of composite sinks covers every size, configuration and price point, so you're sure to find your perfect fit. The range includes round and square models in two different colours – Granite Black and Granite Grey. Select from 1, 1.5 or 2 bowl models, with or without an integrated drainer, with dimensions suited to kitchens from the spacious to the compact. Plus choose between a neat top-mounted model or a sleek, minimalist under-mounted version which sits under the worktop.

FINISHES

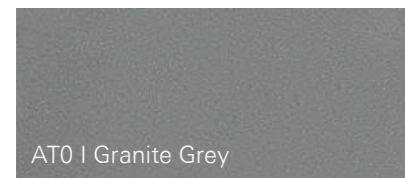

AT0 | Granite Grey

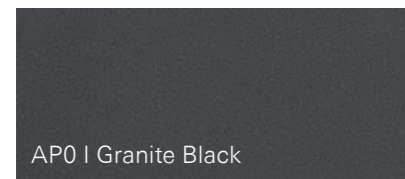

AP0 | Granite Black

QUARTZ COMPOSITE

Your sink can cope with the daily demands of even the busiest kitchen thanks to our innovative composite material. Using 76 % quartz – the hardest part of granite – mixed with acrylic resin, GROHE composite sinks are the toughest around. This hardened composite material is resistant to scratches, dents, stains, cracks and heat up to 280 °C. The smooth surface is easy to clean and 100 % food safe for total peace of mind.

Each GROHE composite sink is produced using a computerized polymerization casting process which guarantees a seamless finish and total uniformity of colour throughout. What's more, the composite won't fade in UV light, meaning it's certain to stay looking as good as the day you bought it.

MOUNTING TYPES

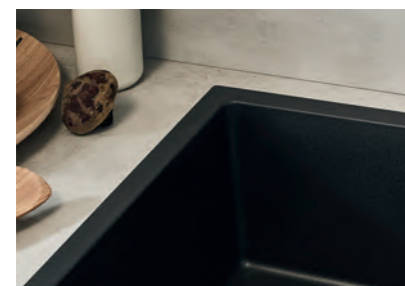

Topmount
A traditional built-in look with a vertical 8 mm edge. Installation is with clips (except for models 31 653, 31 654, 31 655 and 31 648 – silicone only).



Undermount
Installed under the worktop for a sleek, contemporary look.



Waste fitting for easy handling
Thanks to the automatic waste your hands will stay clean and dry. For even more convenience, upgrade your sink with the stylish push-excenter (see page 202).

INNOVATIVE FEATURES



GROHE QuickFix
Install your sink swiftly and easily thanks to the GROHE QuickFix system (kit supplied). With pre-punched tap holes most of our sinks are easily reversible, giving you the flexibility you need for any design scheme.



GROHE Whisper
Shhh! GROHE sinks reduce noise from running water and handling pots to a minimum, thanks to the dense mix of quartz and acrylic in our composite sinks.



Scratch-proof
Putting practicality first – made only from solid composite, these sinks are scratch-proof for a longer life.



Heat resistant up to 280 °C
Never hesitate to put down a hot pot again – GROHE composite sinks are heat resistant up to 280 °C for great durability.



Stain resistant
Because your sink has to be practical as well as beautiful, GROHE composite sinks are stain resistant for long-lasting good looks.



100 % food safe
Enjoy total confidence in using your kitchen your way – GROHE composite sinks are 100 % food safe, making prep easy and hygienic.



Non fading in UV-light
Let the sunshine in! Our composite material won't fade in UV light, keeping your sink looking pristine and the colour-true.



Easy to clean
Your composite sink is easy to keep clean so you will be able to enjoy its flawless finish for years to come.



Spacious bowls
All GROHE composite sinks feature seamless bowls with a generous depth of at least 20 cm maximizing space for washing large pots and filling vases with ease.

GROHE COMPOSITE K700 UNDERMOUNT SERIES

Create a sleek, minimalist look for your kitchen with the K700 undermount series. Mounted below the worktop for a clean, seamless look, this style is an ideal fit for modern, architectural kitchens. These single bowl sinks come with clips to make mounting easy and an optional automatic waste fitting with push-to-open technology. All sinks in the K700 undermount series can also be installed top-mounted for a more traditional look.



Topmount installation



Upgrade your sink with the stylish GROHE push-excenter (fits to all composite series)



32 950 DC0
K7
Professional sink mixer
with dual spray

40 986 SD0
Push-excenter
with pop-up

31 654 AP0
K700 Undermount
Composite kitchen sink
with 1 bowl



● ●
31 653 AP0
K700 Undermount
Composite kitchen sink
with 1 bowl



● ●
31 654 AP0
K700 Undermount
Composite kitchen sink
with 1 bowl



● ●
31 655 AP0
K700 Undermount
Composite kitchen sink
with 1 bowl

Colour options:
● AT0 | Granite Grey ● AP0 | Granite Black



GROHE COMPOSITE **K700 SERIES**

The K700 series of composite sinks offers you premium features and performance, with a deep bowl and generous proportions making them large enough for any kitchen task. Available in 1 and 2 bowl options, models are designed to be top-mounted, with some also suitable for more minimalist under-mounting. K700 series sinks are available with automatic waste fitting and optional push-to open technology.



30 294 DC0
Essence
Professional sink mixer
with dual spray

31 652 AP0
K700
Composite kitchen sink
with 1 bowl



● ●
31 650 AP0
 K700
 Composite kitchen sink
 with 1 bowl



● ●
31 651 AP0
 K700
 Composite kitchen sink
 with 1 bowl

Colour options:
 ● AT0 | Granite Grey ● AP0 | Granite Black



● ●
31 652 AP0
 K700
 Composite kitchen sink
 with 1 bowl



● ●
31 657 AP0*
 K700
 Composite kitchen sink
 with 2 bowls



● ●
31 658 AP0
 K700
 Composite kitchen sink
 with 2 bowls, reversible

* Can also be installed under the worktop.

GROHE COMPOSITE K500 SERIES

Combine durability with spacious proportions and streamlined looks with the K500 series of composite sinks. This flexible collection features 1, 1.5 and 2 bowl options, with integrated drainers available on some models. For an architectural look select an under-mounted design or fit the more conventional top-mounted models. K500 series sinks are available with automatic waste fitting and optional push-to-open technology.



30 270 ALO
Essence
Sink mixer high spout
with pull-out dual spray

31 648 AP0*
K500
Composite kitchen sink
with 1.5 bowls

* Can also be installed under the worktop.



● ●
31 644 AP0
 K500
 Composite kitchen sink
 with 1 bowl
 and reversible drainer



● ●
31 647 AP0
 K500
 Composite kitchen sink
 with 2 bowls
 and reversible drainer



● ●
31 645 AP0
 K500
 Composite kitchen sink
 with 1 bowl
 and reversible drainer



● ●
31 648 AP0*
 K500
 Composite kitchen sink
 with 1.5 bowls



● ●
31 646 AP0
 K500
 Composite kitchen sink
 with 1.5 bowls
 and reversible drainer



● ●
31 649 AP0
 K500
 Composite kitchen sink
 with 1 bowl

Colour options:
 ● AT0 | Granite Grey ● AP0 | Granite Black



* Can also be installed under the worktop.

GROHE COMPOSITE **K400 SERIES**

Combine sturdy practicality, visual flair and great design flexibility with a K400 series composite sink. Designed to be fully-reversible, these top-mounted sinks come in 1 and 1.5 bowl models, all with automatic waste fitting and optional push-to open technology.



31 483 002
Concetto
Sink mixer high spout
with pull-out dual spray

31 642 APO
K400
Composite kitchen sink
with 1.5 bowls
and reversible drainer



● ●
31 640 AP0
 K400
 Composite kitchen sink
 with 1 bowl
 and reversible drainer



● ●
31 642 AP0
 K400
 Composite kitchen sink
 with 1.5 bowls
 and reversible drainer



● ●
31 641 AP0
 K400
 Composite kitchen sink
 with 1 bowl
 and reversible drainer



● ●
31 643 AP0
 K400
 Composite kitchen sink
 with 1.5 bowls
 and reversible drainer

Colour options:
 ● AT0 | Granite Grey ● AP0 | Granite Black



GROHE COMPOSITE K200 SERIES

With the K200 series we've thought of everything. This great all-rounder is an ideal sink for your basic kitchen needs, and is also ideal for compact spaces or islands. The round K200 composite sink is as practical and durable as all of our sinks. Designed to be top-mounted, this single bowl sink comes with optional push-to-open technology.



● ●
31 656 AP0
K200
Composite kitchen sink
with 1 bowl

Colour options:
● AT0 | Granite Grey ● AP0 | Granite Black



30 358 000
Sink mixer

31 656 AP0
K200
Composite kitchen sink
with 1 bowl

FIND THE PERFECT MATCH SINK AND TAP IN PERFECT HARMONY

Everything about the GROHE range of sinks has been designed for a perfect fit – with your tap, with your kitchen, with your lifestyle. All of the sinks have been designed to be paired effortlessly with our kitchen taps and watersystems, both in terms of design and practicality, with comfortable proportions and no splashing. The sinks are available in two colours, both perfectly matched to new GROHE colour options for brassware, which includes Hard Graphite and Warm Sunset colour options.

K700 / K700 UNDERMOUNT



ESSENCE



K7



EUROCUBE



ATRIO



SMARTCONTROL



GROHE BLUE HOME PULL-OUT

K500



MINTA



EUROCUBE



ZEDRA

K400



BAULOO



EUROSART



CONETTO



EUROSTYLE COSMOPOLITAN



EURODISC COSMOPOLITAN

K200



BAULOO











EUROSART

These are our design recommendations for **YOUR PERFECT MATCH**.
Of course any other GROHE kitchen tap can be combined with our kitchen sinks.





GROHE KITCHEN SINK FEATURES

STAINLESS STEEL SINKS

	STANDARD BUILT-IN	FLAT-EDGE	FLUSH-MOUNT	UNDERMOUNT	1	1.5	2	INNER RADIUS	DRAINER AVAILABLE	AISI 304 (V2A)	AISI 316 (V4A)	SATIN FINISH	PVD COLOUR	PRE-POLISHED	PRE-PUNCHED TAP HOLES	REVERSIBLE SINK	AUTOMATIC WASTE FITTING INCLUDED	BUNDLE AVAILABLE
	MOUNTING TYPE				NUMBER OF BOWLS & RADIUS			DRAINER	MATERIAL	FINISH			ADDITIONAL FEATURES					
K1000 			●		●			R10	●	●		●			●		***	
K800 			●		●	●		R10		●		●			●		***	
K700 U 	●		●	●	●	●		R10		●		●	●				***	
K700 	●		●		●			R15		●		●					***	
K500 	●		●		●	●	●	R65	●	●		●			●	●	***	●
K400+ 		●			●	●		R20	●		●	●			●	●	***	
K400 	●				●	●	●	R20	●	●		●			●	●	***	●
K200 	●				●	●		R100/ R60	●	●				●	●	●	***	●

* R0 (bottom, front & back top) / R30 (right & left top)
 ** R0 (vertical) / R9 (bottom)
 *** optional accessory 40 986 SD0

COMPOSITE SINKS

	STANDARD BUILT-IN	UNDERMOUNT	1	1.5	2	INNER RADIUS	DRAINER AVAILABLE	COMPOSITE	PRE-PUNCHED TAP HOLES	REVERSIBLE SINK	AUTOMATIC WASTE FITTING INCLUDED
	MOUNTING TYPE		NUMBER OF BOWLS & RADIUS			DRAINER	MATERIAL	ADDITIONAL FEATURES			
K700 U 	●	●	●			R0 / R30*		●			***
K700 	●	○	●	●	●	R0		●	●	○	***
K500 	●	○	●	●		R0 / R9**	●	●	●	○	***
K400 	●		●	●		R15	●	●	●	●	***
K200 	●		●			R60		●	●		***

○ selected products
 ● all products in this line

GROHE SOAP DISPENSERS

The perfect way to add the finishing touch to your kitchen is with one of GROHE's range of modern and elegant soap dispensers. Practical and durable, they are built with classic GROHE workmanship and designed to match all of GROHE's kitchen taps.



40 535 000
Cosmopolitan soap dispenser
for liquid soaps
storage bin 400 ml



40 536 000
Contemporary soap dispenser
for liquid soaps
storage bin 400 ml



40 537 000
Authentic soap dispenser
for liquid soaps
storage bin 400 ml

Colour options:

- 000 | StarLight Chrome
- DC0 | SuperSteel
- GL0 | Cool Sunrise
- GN0 | Brushed Cool Sunrise
- DA0 | Warm Sunset
- DL0 | Brushed Warm Sunset
- A00 | Hard Graphite
- AL0 | Brushed Hard Graphite
- BE0 | Polished Nickel
- EN0 | Brushed Nickel



GROHE BLUE & GROHE RED WATERSYSTEMS

	DESIGN	MIXED WATER	FILTERED WATER	SPARKLING WATER	KETTLE-HOT WATER	PULL-OUT MOUSSEUR	CO ₂ BOTTLE 425 g	FILTER	FILTER HEAD	CARBONIZER	BOILER	GROHE ONDUS APP	CHROME	PVD COLOURS	PERFECT MATCH	
															SOAP DISPENSER 40 535 000 / 40 535 DC0	WASTE SYSTEMS
GROHE BLUE HOME		●	●	●		●	●	●	●	●		●	●	●	●	●
		●	●	●		●	●	●	●	●		●	●	●	●	●
		●	●	●		●	●	●	●	●		●	●	●	●	●
GROHE BLUE HOME MONO			●	●			●	●	●			●	●	●	●	●
GROHE BLUE PROFESSIONAL		●	●	●		●	●	●	●	●		●	●	●	●	●
		●	●	●		●	●	●	●	●		●	●	●	●	●
		●	●	●		●	●	●	●	●		●	●	●	●	●
GROHE BLUE PROFESSIONAL MONO			●	●			●	●	●			●	●	●	●	●
GROHE BLUE PURE		●	●					●	●				●	●	●	●*
		●	●					●	●				●	●	●	●*
GROHE BLUE PURE FILTER MONO			●					●	●				●	●	●	●*
GROHE RED DUO		●			●			●	●		●		●	●	●	●
		●			●			●	●		●		●	●	●	●
		●			●			●	●		●		●	●	●	●
GROHE RED MONO					●			●	●		●		●	●	●	●
					●			●	●		●		●	●	●	●

* Additional waste bin is needed

GROHE FUNCTIONALITY AT A GLANCE

	DESIGN	FILTERED WATER	EASYTOUCH	FOOTCONTROL	SMARTCONTROL	PROFESSIONAL SPRAY	PULL-OUT TRIPLE SPRAY	PULL-OUT DUAL SPRAY	PULL-OUT MOUSSEUR	SIDE SPRAY	PRE-WINDOW	STOP VALVE	CHROME	PVD COLOURS	PERFECT MATCH – OUR RECOMMENDATION		
															SOAP DISPENSER 40 535 000 / 40 535 DC0	SOAP DISPENSER 40 536 000 / 40 536 DC0	SOAP DISPENSER 40 537 000 / 40 537 DC0
GROHE K7								●		●			●	●	●		
						●							●	●	●	●	
GROHE K7 FOOTCONTROL				●		●							●	●	●	●	
GROHE MINTA					●			●	●			●	●	●	●	●	
								●	●				●	●	●	●	
								●	●				●	●	●	●	
GROHE MINTA TOUCH			●					●					●	●	●	●	
			●						●				●	●	●	●	
GROHE ZEDRA					●		●	●				●	●	●	●	●	
		●					●	●				●	●	●	●	●	
GROHE ZEDRA TOUCH			●				●	●					●	●	●	●	
GROHE ESSENCE					●	●		●					●	●	●	●	
GROHE ESSENCE FOOTCONTROL				●				●					●	●	●	●	
GROHE ATRIO													●	●	●	●	
GROHE EUROUCUBE													●	●	●	●	
						●							●	●	●	●	
GROHE AMBI													●	●	●	●	
GROHE PARKFIELD								●					●	●	●	●	
GROHE EURODISC COSMOPOLITAN								●			●		●	●	●	●	
									●				●	●	●	●	

GROHE FUNCTIONALITY AT A GLANCE

	DESIGN	PROFESSIONAL SPRAY	PULL-OUT DUAL SPRAY	PULL-OUT MOUSSEUR	PRE-WINDOW	STOP VALVE	CHROME	PVD COLOURS	PERFECT MATCH – OUR RECOMMENDATION	
									SOAP DISPENSER 40 535 000 / 40 535 DC0	SOAP DISPENSER 40 536 000 / 40 536 DC0
GROHE CONCETTO		•					•	•	•	
		•	•	•	•	•	•	•	•	
		•	•	•		•	•	•	•	
		•					•		•	
GROHE EUROSTYLE COSMOPOLITAN					•	•	•		•	
			•	•			•		•	
							•		•	
GROHE EUROSMART COSMOPOLITAN					•	•	•		•	
						•	•		•	
			•				•	•	•	
GROHE EUROSMART			•				•	•		•
						•	•			•
							•			•
GROHE BAU							•			•
							•			•
							•			•

GROHE LOW PRESSURE FITTINGS

	DESIGN	PULL-OUT DUAL SPRAY	PULL-OUT MOUSSEUR	PRE-WINDOW	STOP VALVE	CHROME	PVD COLOURS	PERFECT MATCH – OUR RECOMMENDATION
								SOAP DISPENSER 40 535 000 / 40 535 DC0
GROHE ZEDRA		•				•		•
GROHE MINTA			•			•		•
		•				•		•
GROHE CONCETTO			•	•	•	•		•
			•			•		•
GROHE EUROSTYLE COSMOPOLITAN						•		•
						•		•
						•		•
GROHE EUROSMART COSMOPOLITAN						•		•
						•	•	•
						•		•

DISCOVER THE WORLD OF GROHE

If you're looking for ideas or solutions for your bathroom and kitchen, the **GROHE Media APP** is where you will find your inspiration. With a new name and a fresh new look, this app puts all the latest content from GROHE – magazines, videos, books and brochures – at your fingertips. This is just a small selection of what the world of GROHE has to offer: the perfect addition to your GROHE home.

GET IT HERE



VISIT US ONLINE AND FOLLOW US ON SOCIAL MEDIA

FACEBOOK [grohe.enjoywater](#) | INSTAGRAM [grohe_global](#)
TWITTER [grohe](#) | YOUTUBE [grohe](#) | PINTEREST [grohe](#)



System requirements
iPhone with iOS 11.0 or higher / smart phone with Android 6.0 or higher. The Bluetooth® word mark and logos are registered trademarks owned by Bluetooth SIG, Inc. and any use of such marks by Grohe AG is under license. Other trademarks and trade names are those of their respective owners. Apple, the Apple logo, iPod, iPod Touch, iPhone and iTunes are trademarks of Apple Inc., registered in the U.S. and other countries. Apple is not responsible for the function of this device or its compliance with safety and regulatory standards.

Follow us



Just scan the QR code to view the latest brochure as download or PDF on your tablet or smartphone.

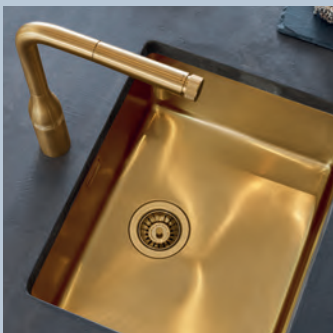

QUALITY

*"No.1 most trusted brand in the sanitary industry" –
Wirtschaftswoche, 2017*

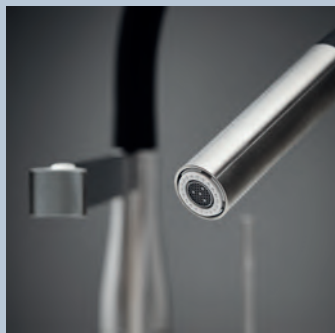

TECHNOLOGY

*"Top 50 companies to change the world" –
Fortune Magazine, 2017*



DESIGN

Over 400 design awards won since 2003



SUSTAINABILITY

CSR Award winner of the German Government, 2017

GROHE Limited
World Business Centre 2
Newall Road
London Heathrow Airport
Hounslow
Middlesex
TW6 2SF
Tel: 0208 283 2840
Fax: 0871 200 3415
email: info-uk@grohe.com

© 05/2020 – Copyright by GROHE