

GROHE MAGAZINE

LUXURY BATHROOMS, KITCHENS,
ARCHITECTURE & WATER STORIES
N°2 2018

GROHE



PRECISELY ELEGANT

How the redesigned line of Atrio faucets combines the best of old and new geometries

TASTE OF MILAN

Four Milanese gastronomic experiences not to be missed and the connoisseurs behind them

LEARNING FROM AFRICA

The continent-spanning, award-winning work of Nigerian architect Kunlé Adeyemi

www.vosoughishop.com

دفتر مرکزی : مشهد، بین قرنی ۳۱ و ۳۳

تلفن : ۰۵۱ - ۳۷۱۳۳۰۰۰

Pure Freude
an Wasser



PERFECT MATCH

GROHE CERAMICS MADE TO MATCH
IN FORM AND FUNCTION

It isn't easy to find the perfect bathroom configuration. But with GROHE Cube Ceramic it couldn't be simpler. All ceramics are designed and engineered to harmonise perfectly with faucets, showerheads and sanitary systems. Also discover GROHE Bau Ceramic and GROHE Euro Ceramic. ceramics.grohe.com

DEAR READER,

When I recently discussed the new Atrio designs with my team, we took a moment to reflect on what it means to be authentic these days. Authenticity is something that we all aim for and yet most of us are a bit unsure what it actually means for our day-to-day lives, including in our work. However, we at GROHE are always thinking about this concept, and have built it into every aspect of how we do business.

At GROHE, we believe in excellence – from creating iconic designs to maintaining the highest production standards while enabling a sustainable attitude to consumer products. Striving for the best – in all areas of our business – is obviously easier said than done. But we've come to realize that we are at our best when we keep the strings in our hands. The more we do in-house, the better our results.

This certainly goes for our design department – headed by our VP of Design Michael Seum – which allows us to treat design as a core responsibility. As a result, great design is in the DNA of everything we do. We have been rewarded with an especially strong winning streak in all the major design awards, including iF, German Design and Red Dot (p. 32), extending our successes in this area. With this in mind, I'm extremely proud to reveal our latest addition to iconic bathroom design: the updated Atrio faucet collection. Presented for the first time during the Milan Design Week 2018 in a stunning installation, it certainly is a prime example of elegance and precision (p. 50).



Michael Rauterkus,
Chief Executive Officer of GROHE AG

Should you find yourself in Milan for the Design Week – or when visiting for some *dolce vita* in the summer – you should also make a beeline for the bars and restaurants of the connoisseurs in our story »Taste of Milan« (p. 10).

No design would be possible without our teams of dedicated engineers, production experts, and programmers: the algorithms that make the award-winning GROHE Sense and Sense Guard water damage protection system have – of course – been developed in-house (p. 36). And on the production side of business, I'm happy to report that we are also one of only a few companies that produce brass parts themselves. You'll find that our recently expanded site in Klaeng, Thailand (p. 30), not only employs the latest production technologies but is also heavily invested in what I call the »family factor.« Our dedication to excellence also shows in our shower lab in Hemer, where engineer Mirja Bensing tests the performance of our shower heads (p. 38).

So what makes GROHE authentic? Being in touch with every part of the cycle from design to production in a very personal way is certainly our biggest asset in that regard. The more of ourselves we put into every step of the process, the more GROHE we become. Yet, in the end, it is you, our readers, customers, and supporters who believe in GROHE and therefore make it a truly authentic company.

Sincerely, Michael Rauterkus

CONTENTS

10

TASTE OF MILAN

We talk to the people behind the finest gastronomic locations in Italy's fashion capital.

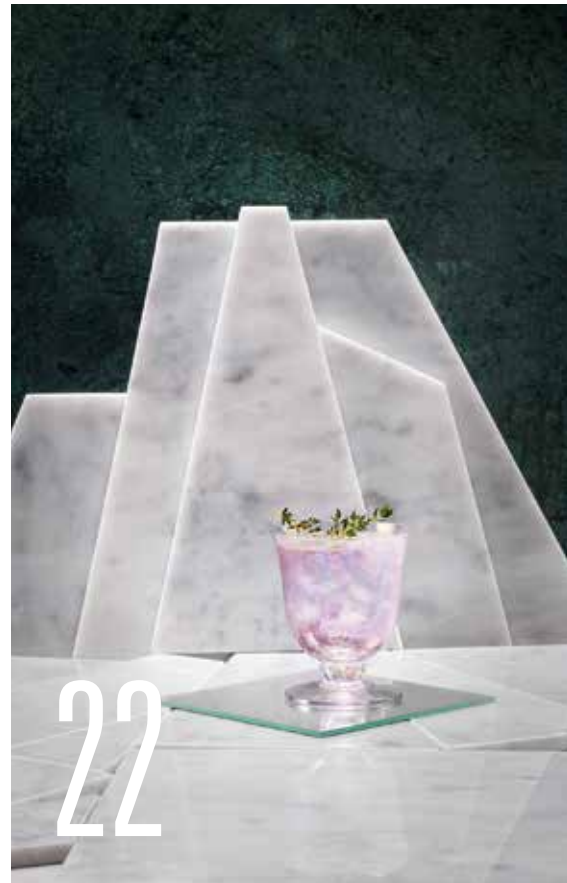

22

ALLA MILANESE

How best to recreate the taste of Lombardy – with the help of GROHE Red and GROHE Blue Home.

FAMILY VALUES

GROHE's plant in Thailand keeps the personal lives of its employees in mind.



30



THE GOLDEN YEARS

2017 was a record year for design awards for GROHE – and 2018 is shaping up to be even bigger.

32

MIX AND MATCH

GROHE's designs offer a whole world of matching fixtures for every bathroom type.

34



36

EXTRASENSORY PERCEPTION

Avoiding the next disaster with GROHE's Sense and Sense Guard.

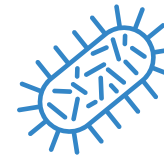

FUTURE HYGIENE

Hotelier Marc Meurin explains how the GROHE Sensia Arena has improved his guests' bathroom experience.



44



38

EXPERIENCE EXCELLENCE

We report from the frontiers of shower head research in a GROHE engineer's lab.

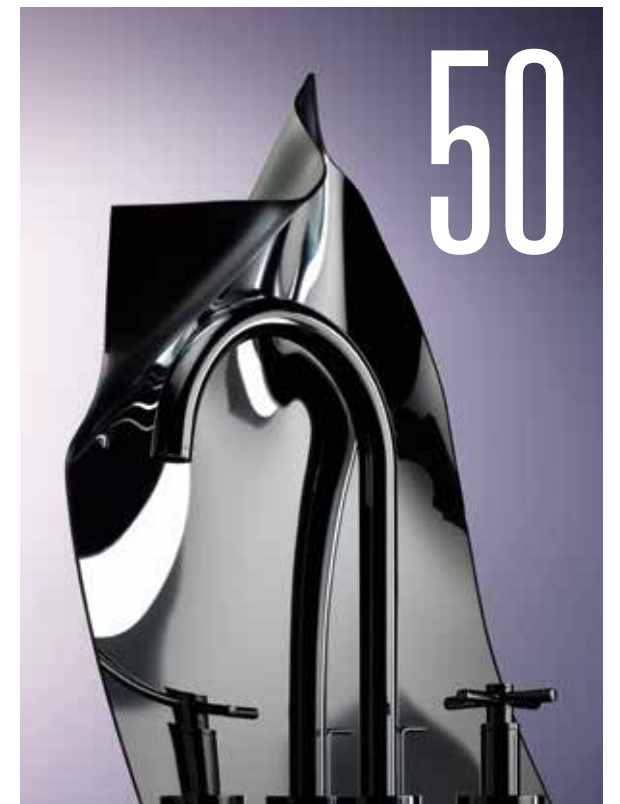

50

PRECISELY ELEGANT

Presenting the new line of Atrio faucets and discussing their redesign with GROHE's VP of Design Michael Seum.

GROHE AG
Feldmühleplatz 15
D-40545 Düsseldorf, Germany
grohe.com

GROHE TEAM
Michael Rauterkus, Gerhard Sturm,
Michael Seum, Jan Shepherd, Thorsten Sperlich

**CENTRAL COORDINATION AND EDITING,
INTERNATIONAL COORDINATION**
Jan Shepherd

PUBLISHING HOUSE
BBE Group, Berlin
bbe-group.de
Managing Director: Christian Bracht

EDITOR-IN-CHIEF
Hans Bussert

CREATIVE DIRECTION
Christian Kúpker

PICTURE EDITOR
Victoria Gisborne-Land

SUB-EDITOR
Josie Thaddeus-Johns

PROOFREADER
Gareth Davies

PRE-PRESS
Veronika Neubauer

CONTRIBUTORS
Senta Best
Henny Bohm
Alexis Christodoulou
Gabrielle Cox
Luigi Fiano
Ramon Haindl
Attila Hartwig
Volker Hobl
Robin Kranz
Marina Melentjeva
Alexandra Pereira
Delphine Saint-Jean
Annalisa Testa
Maarten Willemstein

TRANSLATIONS
Laudert, Vreden
laudert.de

PRINTING
Kunst- und Werbedruck, Bad Oeynhausen
kunst-undwerbedruck.de

The GROHE magazine is translated into 10 languages and appears in 60 countries with a total annual print run of more than 1 million.

No responsibility will be accepted for unsolicited manuscripts and photos received. Despite careful selection of sources, no responsibility can be taken for accuracy.

No part of this magazine may be used or reproduced in any manner whatsoever without written permission. All rights reserved.



KNOWLEDGE TRANSFER

Two pairs of engineers explain how collaboration between Japan and Germany has helped them succeed.



BEST OF TRENDS

The hottest new directions in design, handpicked by the GROHE Design Team.



SPARKLE & FADE

Artist Courtney Mattison creates ceramic artworks inspired by coral to highlight the issues of ocean pollution.

LEARNING FROM AFRICA

Nigerian architect Kunté Adeyemi designs buildings on water that work for people and communities.



BUILDING CULTURE

Three cultural institutions in and around Berlin that have a new design with the help of GROHE.



PORCELAIN DREAM

Dreamlike virtual environments that showcase the beautiful reality of three GROHE Ceramic lines.



WATERMAN

Renowned big-wave surfer Laird Hamilton and his love for the oceans.



DESERT WONDER

Doug Aitken's ranch house made of mirrors offers an architectural reinvention of a mirage.

Pure Freude
an Wasser



INTRODUCING THE NEW CLEAN

GROHE SENSIA ARENA SHOWER TOILET

Now GROHE introduces its revolutionary shower toilet, the GROHE Sensia Arena, providing gentle natural cleansing using just water. The technology and design of the GROHE Sensia Arena takes care of some of your most private moments, inviting you into a new dimension of wellbeing and cleanliness. grohe.com



THE MOST AWARDED GROHE PRODUCT WITH 14 INTERNATIONAL DESIGN AWARDS



INTERVIEWS: ANNALISA TESTA
PHOTOGRAPHY: LUIGI FIANO

TASTE OF MILAN

The city of aperitivo offers myriad gastronomic experiences. Four Milanese taste experts explain what not to miss and share their favorite recipes.

The Camparino in Galleria is named after the famous spirit and is one of the city's most celebrated watering holes.

MATTIA PASTORI, CAMPARINO IN GALLERIA

The Galleria Vittorio Emanuele II, overlooking the *Duomo*, is often nicknamed »il Salotto di Milano« (Milan's drawing room) and is the temple of the *Aperitivo Milanese* – a holy place that has welcomed food and beverage traditions of the city for 103 years. Indeed, besides the city's reputation for fashion and design, the Camparino in Galleria is one of the images most commonly associated with Milan. It was the place that gave birth to one of the most famous spirits in the world, Campari Bitter, as well as the tradition of the aperitif. We spoke to Mattia Pastori, store manager of the Camparino and also World Class Italy Bartender of the Year 2016.

GROHE

How important is the Camparino in Galleria for Milan?



Find Mattia Pastori's recipe for the GROHE Fizz on p. 26.

Mattia Pastori

Everyone has come through here – it is said that even Italian opera composers Arturo Toscanini and Giuseppe Verdi were addicted! This is a place with an eye on the future but a hand firmly on the wheel of its origins.

G What exactly does »Aperitivo Milanese« mean?

MP **It's a social phenomenon, that moment that most people spend all day waiting for: relaxing, talking about their day, and drinking cocktails. From the Negroni and the Negroni Sbagliato to Americanos, Shakered Camparis, and Campari Spritzes.**

G Innovation or tradition: what is the link between past and future at the Camparino?

MP **To innovate with the tradition. This is our goal today. Take the Campari and Seltz, for example: In 1915, a hydraulic system leading from the cellar used to guarantee a continuous flow of iced soda water to the bar. But today we have figured out a new system that gives the same service. The drinks list is always the same, but with a contemporary twist.**

G Can you tell me about the cocktail list? What is the current trend?

MP **It's built on Italian classics: Campari and Seltz and Shakered Campari first. And then we have twists on the signature like the Campari, Rabarbaro, or the Boulevardier – a cocktail based on the Negroni recipe but with whiskey instead of the gin.**

G And what about the food menu?

MP **For an aperitif, we propose more contemporary finger food, like mini burgers with Chianina beef and fish tartare served on bread, the perfect pairing for the »GROHE Fizz« – a celebration of Milan. It's a twist on the Gin Fizz made by mixing Campari Cask Tales Bourbon Bitter with salty saffron syrup and grapefruit juice, topped with sparkling water and an edible flower and grapefruit peel garnish.**

CAMPARINO IN GALLERIA, Piazza del Duomo, 21, Milan





ERIKA ROSSI, WOOD*ING BAR

It's not customary for lichen, wild musk, a beech twig, or the sap of a birch tree to become food. Or ingredients for cocktails. But in the hands of the agronomists, chefs, chemists, herbalists, and bartenders that are part of the Wood*ing Lab team, a laboratory born in the suburbs of Milan five years ago, they became protagonists of fascinating recipes with unique flavors. We spoke to Erika Rossi, bartender at the new Wood*ing Bar, which recently opened in the heart of the Isola neighborhood in Milan.

GROHE

How did you end up at this unconventional cocktail bar?

Erika Rossi

I've always been fascinated by the alchemy of the cocktails, the magic behind the mixing of different

ingredients that transforms a liquid into a delicious, balanced, and perfect drink. This curiosity led me to travel and explore historic hotel cocktail counters, and one day I met Valeria Mosca, founder of Wood*ing Lab, the first and only food lab in the world that works exclusively with wild food. That's how I discovered wild mixology, which experiments with forgotten ingredients or new processing techniques and that represents the future of this work.

G What is this new mixing philosophy?

ER **It's all about an intelligent way to drink. We want to make guests experience innovative, healthy, sustainable, balanced drinks. Wood*ing Bar is not just something abstract, but a real rediscovery of the**

aromas and flavors of our family traditions, often forgotten over time. I think we are bringing a kind of revolution into the cocktail world!

G Non-alcoholic drinks are very often overlooked, but at the Wood*ing Bar they become protagonists of the cocktail menu.

ER **The constant research into raw materials allows us to overshadow the use of alcoholic products and detach from the usual idea that a good cocktail must be alcoholic. The one we suggest for a taste of Milan is the Spring Bouquet Collins. It's a refreshing take on a classic using Memento, a blend of distilled aromatic waters filled with the scents of the Mediterranean, kombucha with wild rose petals, some drops of blackberry vinegar, and finally some thyme syrup topped off with sparkling water.**

G What role does water play at the Wood*ing Bar?

ER **Fundamental, given the importance we give to the environment in our eco-sustainable mixology. It deserves a place of honor in our recipes. This is why we choose to use only purified water.**

WOOD*ING BAR. Via Garigliano, 8, Milan



Discover the Spring Bouquet Collins by Erika Rossi on p. 25.

NICOLA SCARNERA, ITER MILANO

It's a simple concept: »From Italy to the world« – an international search for aromas, flavors, and traditions in every corner of the world. This is the claim of Iter, the first fusion pop-up cocktail bar in Milan, also serving a small tasting menu. The navigators of this trip are Flavio Angiolillo and Nicola Scarnera, who previously launched Mag Cafè, Backdoor43, and Barba, all highlights of Italian mixology. Every six months they will explore a different country, returning to Milan with a culturally enriched suitcase of flavors. Nicola Scarnera is the bar manager at Iter, and previously worked at Sketch in London and The Bulgari Hotel Milan.

GROHE

What is the first stop on your journey?

Nicola Scarnera

Italy, of course. As Italians, we diffuse into other cultures, but we also let them diffuse into ours. That's why we decided to talk about Italy through its gastronomic culture and rediscover Italian products. Our country has a deeply rooted and very varied gastronomic tradition. We want to give space to the infinite facets of Italy, but, every six months, everything will change.

G Which country are you »exploring« for the menu at the moment?

NS **The Netherlands. We launched the new list in March, which talks about our latest travel experience there. Each drink has an Italian-Dutch twist and each dish**

brings with it an anecdote or a story to be transmitted to our guests.

G What are the Dutch cocktails and their ingredients?

NS **We have several drinks with Ketel One, a vodka distilled in Schiedam, and many cocktails with jenever, an excellent Dutch spirit. We even have a dessert with a marijuana meringue, a herring inspired by the markets where we tasted it, and a stew of beef that revisits the Dutch *stamppot*. Until September, that is, when we leave for our next destination.**

G What is the design style of Iter?

NS **We just want to make guests feel at home. The most important piece of a cocktail bar is the counter. We wanted it to be the most comfortable and most coveted place in the room. Since the bar counter is the same height as a table, you can comfortably eat there. Last but not least, we have inserted a tub with ice, so you can always keep your drink cool while you are eating.**

G What is *the* drink to order when visiting Milan?

NS **Its name is ToniCO₂, a delicious mix of white vermouth, Bitter del Ciclista, Amaro Gariga, citric acid, our own homemade Iter aromatic bitter and a top of sparkling water. Super refreshing!**

ITER, Via Mario Fusetti, 1, Milan



Nicola Scarnera's recipe for the ToniCO₂ can be found on p. 24.



ROBERTO CONTI, TRUSSARDI ALLA SCALA

It's a combination of two icons of the city of Milan: the Teatro alla Scala, that Milanese people simply call La Scala, on the one hand; and an important family that contributed to writing the history of Italian fashion on the other – the Trussardi family, with their famous greyhound logo.

The meeting of the two has given birth to one of the most elegant, romantic, and gourmet restaurants in the city, which appeals to Milanese and international visitors alike. Overlooking the majestic theater and the square in front, with its monument to Leonardo da Vinci, the Trussardi alla Scala was opened in 2006, and today it boasts a Michelin star won by the young chef Roberto Conti just a few months ago. His creations are designed to amaze and enchant guests, but the importance of taste is always the ultimate goal. »The Trussardi alla Scala Restaurant prides itself on the seasonality of its menus, using only the best raw ingredients to seduce the palate,« he says. We talked to this hardworking chef about his culinary tastes.

GROHE

What were your first steps in the kitchen?

Roberto Conti

My passion for food started when I was young and it has been nourished over the years. I went to one of the best cooking schools in Italy and was able to experiment with what I have learned and expand my sensibility in the kitchen while working alongside top chefs. I was Andrea Berton's first chef and Luigi Taglienti's sous chef afterwards: this all brought me to being executive chef at Il Ristorante Trussardi Alla Scala.

G Can you please define Milanese style in terms of culinary practice?

RC **Respecting the traditional dishes, but redeveloping them in a contemporary way.**

G How important is the idea of »Made in Italy« at the moment?





Learn how to prepare Roberto Conti's *Cacio e Pepe* on p. 27.

RC It is always completely essential: in the ingredient choice, in the interpretation of the dishes, and in the definition of the menu. It is a key element that we would like to offer our clients, through truly respecting everything that is Italian.

G Milan is the city of fashion, design, and gastronomy. What is the link between these three fields, in your opinion? Is it possible to find a little bit of everything in your dishes?

RC A person entering our restaurant is expecting the best raw materials and plating arrangements, as we are a restaurant that combines food and fashion. We want to offer an experience that engages all the senses and be a place that always surprises guests with its style and taste.

G Innovative or traditional: how do you define the culinary style of Trussardi Alla Scala?

RC We always start by researching dishes from our tradition, but read with an innovative attitude that is never exaggerated. We are able to do this also thanks to our young staff with a consolidated gourmet background – it takes respect to understand the great Italian tradition and a deep sense of taste to interpret it.

G The quality of your raw materials is one of the milestones of your restaurant's experience. How do you choose ingredients? Which flavors do you like most?

RC We look closely at where all our ingredients come from and we research the best suppliers. I don't have a favorite taste. The incredible combination of different flavors that you don't expect to work together but do anyway, that's my favorite.

G What kind of techniques do you use in the kitchen? Do you experiment with new methods?

RC We are always trying new techniques with a gourmet twist. Lately we have been experimenting with a barbecue – not conventional for a restaurant with our level, but we are interpreting it with a Michelin-star perspective.

G What are Trussardi Alla Scala's iconic dishes? And what are you cooking for GROHE Magazine?

RC The iconic *cotoletta alla Milanese*, deep fried in clarified butter and served with Hollandaise sauce and potatoes: imperative for a restaurant in Milan's city center. And then you have to try the *spaghetti cacio, pepe e ricci di mare* that I also selected for GROHE. We use *spaghetti di Gragnano*, one of the most famous types of pasta internationally, cooked in purified water and topped with extra virgin olive oil and basil leaves, with a delicious mix of Sarawak, Sichuan, and Penja pepper, two different qualities of Pecorino cheese and a sea urchin ragù.

TRUSSARDI ALLA SCALA, Piazza della Scala, 5, Milan



ALLA MILANESE

SPAGHETTI
CACIO E PEPE

WITH SEA URCHIN RAGÙ
by Roberto Conti, recipe p. 22

PHOTOGRAPHY:
ROBIN KRANTZ & VOLKER HOBL

Recreating the tasty flavors of Milan
becomes *molto facile* with GROHE Red
and GROHE Blue Home.

TONICO₂

by Nicola Scarnera



45 ml Bitter del Ciclista
30 ml white vermouth
15 ml Amaro Gariga
5 ml citric acid
75 ml GROHE Blue Home sparkling water
5 dashes Iter aromatic bitter

Fill Bitter del Ciclista, white vermouth, Amaro Gariga, and citric acid into a shaker. Shake for ten seconds before pouring into a tumbler. Add homemade Iter aromatic bitter and a top of GROHE Blue Home sparkling water.

SPRING BOUQUET COLLINS

by Erika Rossi



50 ml Memento (non-alcoholic distillate from the Mediterranean)
30 ml kombucha with wild rose petals
5 drops wild blackberry vinegar
25 ml thyme syrup
GROHE Blue Home sparkling water

Begin by mixing Memento with wild rose petal kombucha. Add the blackberry vinegar, thyme syrup, and a top of GROHE Blue Home sparkling water. Garnish with a sprig of thyme.

GROHE FIZZ

by Mattia Pastori



60 ml Campari Cask Tales
5 ml salty saffron syrup
10 ml juniper bitter
20 ml grapefruit juice
GROHE Blue Home sparkling water

Mix the Campari Cask Tales Bourbon with juniper bitter, salty saffron syrup, and grapefruit juice. Top off with GROHE Blue Home sparkling water and a garnish of edible flower and grapefruit peel.

These recipes, from three of Milan's most knowledgeable barkeepers and one of the city's Michelin-starred chefs (see pages 12-20 for their interviews), celebrate the best of the Lombardian capital's tastes. And while unique in their tongue-tingling and spirit-lifting essence, they have one thing in common: aspiring Milanophiles can create them at home with ease with the help of GROHE Blue Home and Red systems. Both provide the filtered water that is needed for any gastronomic creation. GROHE Blue Home (now available with a pull out hose) then allows for the water to be carbonated straight from the faucet – without the fuss and waste that comes with bottled water. And any pasta is cooked a lot faster when the boiling hot water comes directly from a GROHE Red faucet. The following recipes are to be tried at one's own risk, since moving to Milan is not an option for everyone.

SPAGHETTI CACIO E PEPE

WITH SEA URCHIN RAGÙ

by Roberto Conti

Serves four

320g spaghetti, preferably from Gragnano
2g Sarawak peppercorns
2g Sichuan peppercorns
2g Jamaica peppercorns
2g Penja white peppercorns
75g Roman Pecorino
95g Tuscan Pecorino
10g cornstarch
350g whole milk, fresh
1 garlic clove
5 basil leaves
16 sea urchins, shelled
3 ½ tbsp butter
1 tbsp tomato sauce
Purified water, coarse salt and olive oil to taste

Dice 75g of Tuscan Pecorino and 75g of Roman Pecorino. Melt the cornstarch into 50g of whole milk and put the rest of the milk into a casserole dish over high heat. When the milk starts boiling, add the cornstarch-milk mixture, whisk it, and lower the flame to medium heat; cook for one minute, until thick.

Remove the casserole from the heat, and then add the diced Pecorino. Cover with film and let it sit for five minutes. After these five minutes, use an immersion blender to blend the mixture.

Over a low heat, add the 16 sea urchins – which should already be shelled – into a pan alongside a slightly crushed garlic clove, one basil leaf, a tablespoon of extra virgin olive oil and the tomato sauce, and stir for one minute. Cover the pan with film and set aside.

Fill a large pot with boiling water from the GROHE Red faucet. Place on hot stove before adding salt and spaghetti. While the pasta is cooking, crush the various peppercorns on a cutting board, then put them into an infusion sachet.

Pour four glasses of boiling water from the GROHE Red into a saucepan. Add the sachet containing the peppercorns. Let it sit for two minutes before removing the bag.

Combine the pepper-flavored water, butter, and Pecorino fondue in a skillet, over a high heat. Drain the pasta and add it to the skillet, then toss for two minutes.

Arrange the spaghetti onto plates, then top with the sea urchin mixture, some freshly grated Tuscan Pecorino and a dash of cold-pressed extra virgin olive oil. Garnish with a basil leaf.



Chef Roberto Conti is all about reinventing traditional recipes with a contemporary twist, like this pasta dish.



The GROHE Fizz, created by Mattia Pastori, offers a celebration of Milan.



Get a taste of Wood*ing Bar's wild mixology with the Spring Bouquet Collins, courtesy of Erika Rossi.



Pure, filtered GROHE Blue Home sparkling water is key to Nicola Scarnera's cocktail, the ToniCO₂.

*Pure Freude
an Wasser*

GROHE
WAVES



PERFECT TASTE
STRAIGHT FROM THE TAP

STILL, MEDIUM OR SPARKLING
GROHE BLUE HOME



100°C
STRAIGHT FROM THE TAP

BOILING HOT WATER ON DEMAND
GROHE RED

GROHE WATERSYSTEMS

For more information please visit grohe.com

At Klaeng, GROHE has built the most sustainable plant of its kind in Southeast Asia.



TEXT: HENNY BOHM

FAMILY VALUES

As GROHE expands its plant in Klaeng, Thailand, the company is growing a well-connected business that is as sustainable for the planet as it is for families.



At 12,000 square meters, GROHE has introduced a new manufacturing technology for zinc parts at Klaeng, adding to its existing production of brass mixers.



With an average age of around 30, the factory has a lot of families on staff.

Alongside investment in its three German factories, including the expansion of the production plant in Lahr, GROHE is also stepping up in its engagement in Thailand. The plant in Klaeng – which with 1,700 employees is already the company’s largest – will see an investment of more than 30 million USD and will create 800 new jobs within five years.

here in Klaeng, we are taking our growth to the next level.«

The new factory building is 12,000 square meters and enables GROHE to introduce new manufacturing technology for zinc parts, adding to its existing production of brass mixers. »We’re running a full-scale production of one-hand mixers, with all products passing the complete value chain in-house. From melting the zinc or brass, die casting, machining, polishing, and electro-plating, to assembling the finished product and shipping it to the customer,« says Ralf Goehringer, GROHE Siam’s Managing Director since 2015.

After all, matching a rise in customer demand doesn’t mean having to compromise elsewhere: with this facility, GROHE has built the most sustainable plant of its kind in Southeast Asia, achieving the DGNB silver certification for sustainable building from the German Sustainable Building Council. To save resources, solar panels have been installed on the entire roof of the building and will reduce CO₂ emissions by about 1,000 tons every year. High standards are also used in the approach to water wastage. Domestic wastewater is treated biologically so it reaches shower quality and is reused for irrigation and flushing.

Mostly focusing on the Eurosmart and Bau lines, the plant in Klaeng is currently producing around seven million parts each year. When the setup phase is completed in 2021, the capacity in Klaeng will increase to 12 million. GROHE CEO Michael Rauterkus explains the plant’s role in the company’s overall growth strategy: »22 years ago, GROHE Siam started as a small factory. Now it is one of the largest manufacturers of one-hand mixers in the world. With the expansion of our sites, such as

This all speaks of GROHE’s long-term investment in the region, where its social impact meets sustainability standards. Ralf Goehringer points out: »We have a lot of families among our employees. In fact, we are what you could call a ›young‹ facility. Our employees are, on average, around 30. On the other hand, some of the older employees have been with us for over 20 years, sometimes since our first year here.« A long-term family work commitment is something Goehringer himself is familiar with: His own father worked at GROHE for over 50 years. In fact, Goehringer junior grew up next to the plant in Lahr, Germany. He even got his first summer job there: painting tanks when he was 15.

Ralf Goehringer has been GROHE Siam’s Managing Director since 2015.



THE GOLDEN YEARS

GROHE

TEXT: HENNY BOHM

GROHE, the world's leading provider of sanitary fittings, received a number of accolades at the prestigious 2018 iF Design Award. The official awards ceremony, attended by 2,000 guests, took place on 9 March at BMW Welt in Munich. The iF Design Award jurors faced a difficult task this year due to the record number of submissions, with 6,402 entries from 54 countries. The acclaimed designers at GROHE continued their winning streak from the previous year by receiving seven awards, two of which were gold, for their intelligent designs.

The first design to win the iF Design Gold Award was the Sense Guard – GROHE's water control unit for the smart home, which detects frost risk and micro leakages, and shuts off the water supply in the event of a burst pipe. Members of the jury lauded the »elegant design and user-friendly interface« and »exceptional functionality paired with a minimalist exterior.« Success continued with the GROHE Essence Professional, a delicately designed faucet featuring a silicone hose available in a multitude of colors, which won the second iF Design Gold Award. Jurors emphasized the »intelligent mix of different materials and colors of the high-quality product« and praised it as »a high-end professional product that is joyful to use, with material quality you can feel.«

GROHE garnered five additional iF Design Awards for the Conchetto Professional faucet, which features cylindrical

GROHE celebrates success at the 2018 iF Design Award, winning two Gold Awards. With 24 awards won in 2018 so far, GROHE's design team continues their winning streak from the record year of 2017.

#GROHEGOLD



GROHE Vice President of Design Michael Seum and his team at the iF Design Award ceremony on 9 March 2018.

forms in varying dimensions, uniting to create an individual aesthetic; the SmartControl Round, a shower control with new, additional combination options for a multifaceted experience; and the Lineare New bathroom faucets collection, characterized as »sensual minimalism« due to its slim dimensions, clearly defined silhouette, and remarkably balanced proportions. The last award was for the GROHE Design Showreel, produced with the intent of spotlighting the passion, precision, and high level of detail present in every product – it's a video that represents the company's philosophy on a visual and emotional level.

»My team and I are very happy about this outstanding recognition of our work,« says Michael Seum, Vice President of Design for GROHE. »Looking back on a very successful year for GROHE design in 2017, this highly appreciated recognition proves to us yet again that GROHE pursues its design philosophy with the greatest success. What's more, GROHE products, regardless of style, are always easy to use, intuitive, and provide a high level of performance.« In 2017, GROHE participated in 17 international design competitions and won 62 design awards, an unprecedented amount of prizes. These awards included five Red Dot Design Awards (Europe), three Good Design Awards (Japan) and the International Design Excellence Award (USA). At the time of print, GROHE had already won 24 design prizes in 2018, marking the company's distinguished role in bathroom and kitchen design.

MIX AND MATCH

There's no need to go to the ends of the earth to achieve a perfectly harmonized bathroom – GROHE's designs offer a whole world of matching fixtures for hotels and private bathrooms alike.

TEXT: HENNY BOHM

The old spa town of Wiesbaden has a new bathing paradise: the Radisson Blu Schwarzer Bock, which has recently been renovated using only GROHE fixtures for the bathrooms. The hotel, which was originally opened as a bathing house in 1486, is making sure guests also enjoy the spa town's water in the privacy of their hotel rooms, using GROHE's complete design solution. And if they want to take this GROHE bathroom experience home with them? No matter who the guest is, GROHE is able to provide a coherent, coordinated bathroom – all from one supplier – while



set the tone of a room, bringing with them emotions, associations, and some subtle interior sparkle. Whether preferences run more towards a monochrome spectrum or brighter shades, GROHE SPA Colours can be applied to every element of bathroom brassware, from faucets to bath fillers. The high-quality color spectrum includes ten options: chrome, supersteel, brushed or polished Cool Sunrise, brushed or polished Warm Sunset, brushed or polished Nickel, and brushed or polished Hard Graphite. Though chrome is the norm for shower fixtures, on request they can be customized in another one of the SPA Colours. GROHE's fixtures provide total flexibility in creating a harmonious scheme, while inside, cutting-edge technology promises reliable, unbeatable performance. Marble, concrete, stone, and different types of wood can be paired with these colorful fixtures to create a look that is exactly matching but completely unique. In a world where we are surrounded by so many choices, it's essential that a bathroom offers exactly the same amount of flexibility while also keeping that all-important consistency. And where else but GROHE?



The Radisson Blu Schwarzer Bock in Wiesbaden has all new bathrooms courtesy of GROHE.

guaranteeing the PerfectMatch and a perfect water experience, the only brand to do so.

As guests at the Wiesbaden Radisson can discover to their delight, GROHE offers superior style, performance, and durability, making it simple to design a bathroom that fits congruously with GROHE's extensive range of bathroom fixtures – from faucets and showers to the Sensia Arena shower toilet and ceramics. This means visitors who wish to recreate that fluffy-towel hotel feeling at home in their personal surroundings can achieve the same matching finish by using GROHE's bathroom ranges, which are guaranteed to fit together and ensure a hassle-free experience. The full bathroom solutions include safe showering for all generations, bathrooms for the elderly, child-friendly bathrooms, solutions for small bathrooms, and many options for large, luxurious bathrooms.

GROHE bathrooms can also be customized and designed to suit every personality, including those who enjoy more vibrant tones in their bathrooms. After all, colors are often a way to



GROHE's Sensia Arena turns every bathroom into a spa.

EXTRASENSORY PERCEPTION

After dealing with water damage, many homeowners turn to their plumber for a solution. Here, an installation expert and a homeowner describe how GROHE's Sense and Sense Guard help to avoid the next disaster.

HOMEOWNER

»Recently, my family and I unfortunately experienced a large amount of water damage due to a leak in the bathroom. We had noticed a moldy smell at first, but didn't know where it was coming from. Then, after a few months, the laminate flooring started expanding and you could actually hear it squelching when you walked over it. So, of course, we knew something was seriously wrong, but we never imagined just how bad it was. The whole debacle cost 15,000 euros! The insurance covered more or less half of the costs, but the other half had to come out of our own pockets. Not only that, we had to stay at my mother's house for over two weeks because the mold formation was considered dangerous to our health and the entire damaged area had to be torn down and rebuilt. Before that, I wasn't even aware something existed that could potentially prevent a situation like ours, so I think everyone should know about GROHE Sense and Sense Guard. Since we installed GROHE's water management system, we have peace of mind that we will never experience a similar situation again. If something happens to our water system, I won't be suddenly confronted with a leak when I return home. The smart system ensures that your home gets more comfortable, too. Now, because of the Sense Guard, I can leave home trusting that nothing will go wrong – it's reassuring to know that there's something paying attention and caring for our home.«

INSTALLATION EXPERT

»I specialize in installing the GROHE Sense and Sense Guard water security system. Water leaks can cause a huge amount of damage and expense for homeowners. What's worse is that much of the damage occurs before you even know there is a problem. That's why a water sensor that detects flooding and changes in humidity, alerting you automatically, is an essential tool in today's smart home. The GROHE Sense Guard can be installed in almost all houses in about 90 minutes, as long as there is a mains pipe that only services the individual house. Sensors are best placed at the water meter – under the hot-water heater or central heating boiler in the kitchen or bathroom or close to the washing machine. Once the Sense Guard is installed, it constantly monitors all water flow, from dripping toilets to filling bathtubs. Microleaks and pipe-breaks are detected fast by GROHE Sense Guard, so you or Sense Guard can act quickly, shutting off the water. In the event that a flood occurs somewhere, a signal is transmitted to the Sense Guard, after which it will cut off the entire water system, avoiding a considerable amount of water damage. To keep an eye on everything from a distance, simply download the GROHE ONDUS app to your phone and connect it to the devices; it will immediately inform you of a leak at home while you're away. The GROHE Sense water security system is truly the best pain-free solution for the possibility of water damage.«

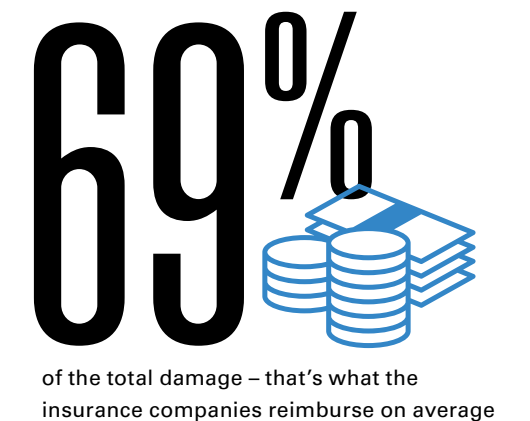
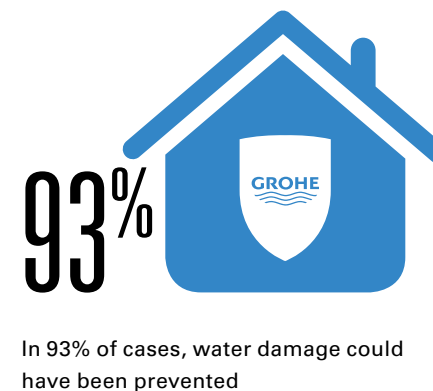
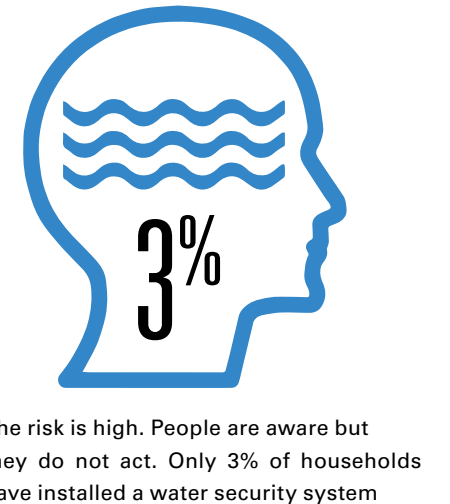
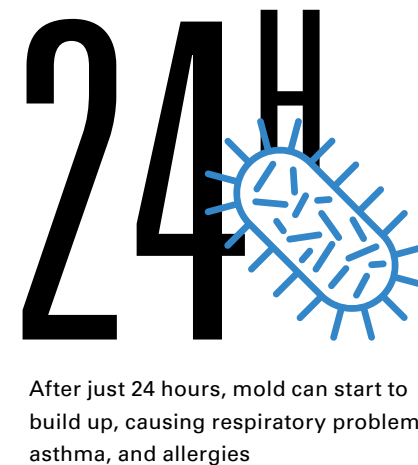
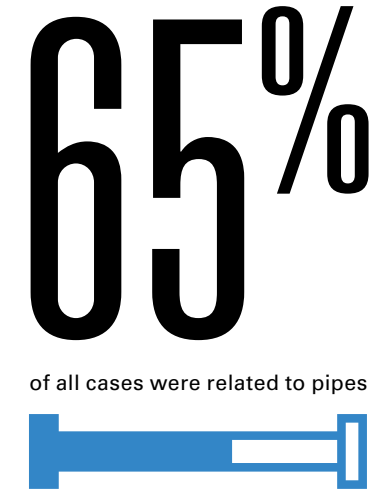
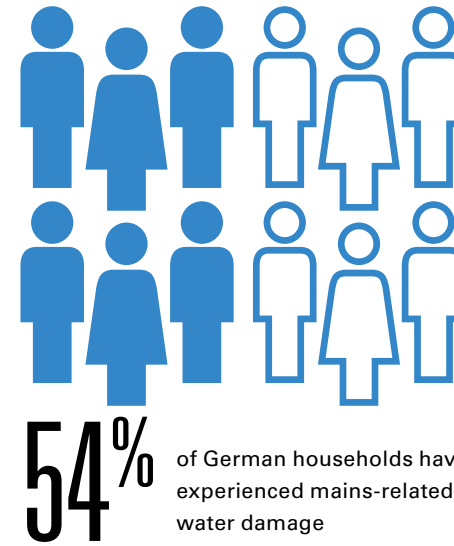

All figures refer to the German market.

How well do GROHE's shower heads actually work?
And how can they provide the optimal shower experience
while using the least amount of water possible? To find out,
engineer Mirja Bensing developed the GROHE shower lab.

EXPERIENCE EXCELLENCE

TEXT: SENTA BEST
PHOTOGRAPHY: RAMON HAINDL



Mirja Bensing got in touch with the shampoo manufacturer Henkel for her research.



The same amount of identical shampoo is used for every test.

In German, a euphemism for a »wimp« is a *Warmduscher* – someone who takes their showers warm. Even so, GROHE engineer Mirja Bensing says with pride: »I am definitely one of those people who prefers to shower with warm water!« A good shower experience is of utmost importance to her, and not just when it comes to using her own shower – she works at GROHE in the field of shower spray development. As an engineer, she tests prototypes and end products, but is also involved in their development. Recently, she had a groundbreaking idea for GROHE that she is now working on: the shower lab. She explains how this idea came about: »We're always testing showers with new spray types for defects and functionality. But until now, we never examined how good our spray patterns really are and how we can optimize them further, especially in terms of protecting the environment.« Simply reducing the flow is not enough to save water – anyone who has already tried to rinse shampoo out of their hair at the pool knows that rinsing takes much longer when there is less water coming out of the shower head. Bensing is therefore looking into what a test system for showers could look like. She quickly had the idea that the environmental aspect in particular could be interesting for shampoo

manufacturers and got in touch with the Henkel company. They were immediately hooked on the idea, since Henkel is also strongly committed to having as small a carbon footprint as possible. Both companies therefore decided to join forces and develop the so-called shower lab. In this lab, tests are now carried out using Bensing's simple but effective system.

The shower lab is made up of two identical test benches, allowing the two results to be compared – one is located at GROHE, the other at Henkel. The shampoo company conducts their experiments from a chemical angle, testing various formulas of shampoo, conditioner, treatments, and dyes, while GROHE approach the problem from a technical standpoint and examine everything pertaining to the shower head. Both are measuring the water's conductivity and turbidity (its cloudiness) by using standard measuring devices – before and after the rinsing process. The test benches were built by Mirja Bensing right here in the GROHE lab.

Her shower lab is located at the back of the huge GROHE lab, where things clatter, roar, and whoosh all over the



Bensing's shower lab examines shower head spray patterns, analyzing how they can be optimized to save water and increase efficiency.



The concept of the shower lab is very simple: Bensing installed a container on the outlet that measures the cloudiness of the waste water. This makes it possible to evaluate the rinsing process.

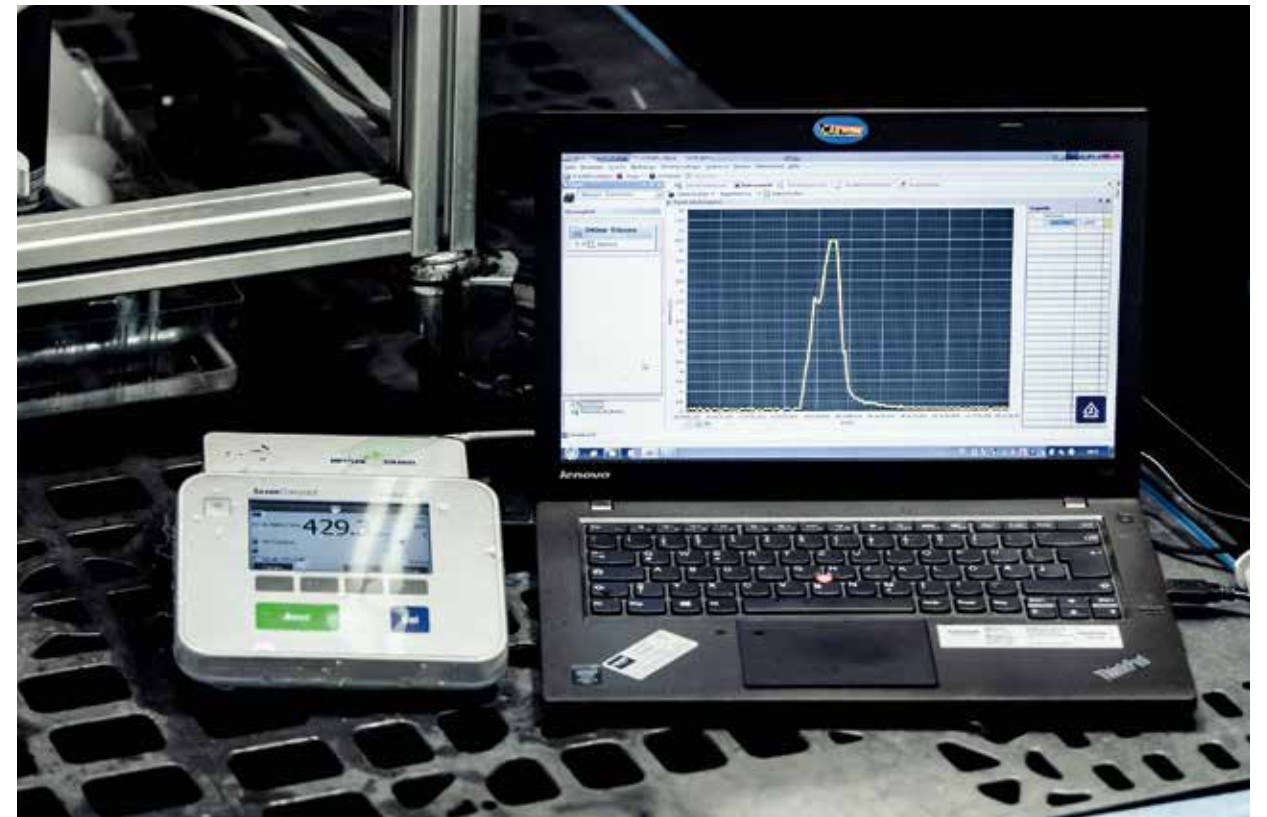

The shower lab is connected to a computer that records the results using a measuring curve.

place. This is thanks to the different devices and test stations which, Bensing explains, can be used universally for any test setup. It looks like a small shower stall. On the floor of the experimental layout is a Henkel-sponsored doll's head, whose short haircut reveals the substantial number of shampoos and rinses that it's already enjoyed in its short lifetime. Another, still-intact head with slightly longer, real hair is already waiting in front of the shower for future use. On the glass shower screen is an energy efficiency label, just like the ones that can be found on refrigerators. Bensing laughs: »My colleagues like to have fun. The idea behind it is that one day we'd like to create a type of seal for our shower heads, especially in relation to water consumption. Most likely my colleague stuck this label on my workstation to motivate me.«

The concept of the shower lab is very simple: Bensing installed a container on the outlet that measures the cloudiness of the waste water. This makes it possible to evaluate the rinsing process. »Our test procedure goes like this: install the shower head, make the hair wet and shampoo it, rinse, change the shower head or spray type, shampoo the hair, rinse it out, and then compare the results,« explains the engineer. The flow rate is reviewed, as well as the time it takes for the water to run clear again.

The procedure requires always using the same amount of identical Henkel product. One series of tests, for example, involves measuring how fast shampoo is rinsed out at different temperatures – which means that only the temperature changes, while the spray type and water flow stay the same.

One small piece of plastic plays an important role in these tests: the flow regulator. It is built into the vast majority of shower heads and is indispensable in the US market, for example, where water consumption is more strictly controlled. As its name implies, a water flow regulator regulates the flow of water and makes sure that the same amount of water always flows from the spray plate, no matter the amount of water pressure in the pipe. »This is of course helpful for us, since the water flow in our experimental setup remains constant thanks to this simple mechanism,« says Bensing.

One step at a time, she has carefully and thoroughly approached all angles of this topic and has now completed the shower lab after a pilot phase of about a year. Now the tests can begin in earnest. Before the end goal of the energy efficiency label is possible, however, the trial doll's head will have to take a few more showers.

FUTURE HYGIENE

Marc Meurin explains how he has become a convert to the GROHE Sensia Arena in his hotel Le Château de Beaulieu and beyond.

INTERVIEW: HENNY BOHM



A hotel's main endeavor is to provide the utmost comfort to its patrons. No one knows that more than Marc Meurin, the renowned Michelin-star chef who runs the 4-star hotel Le Château de Beaulieu as well as the two-Michelin-star gourmet restaurant it houses, which bears his name. In particular, he has discovered that the GROHE Sensia Arena shower toilets have not only been a positive investment for his guests, but for the hotelier himself. A member of the Relais & Châteaux association and located in Busnes, France, Le Château de Beaulieu was recently renovated for its 10 year anniversary and, as part of this renovation, installed GROHE Sensia Arena shower toilets in its classic and charming accommodation. Sensia Arena's innovative functions are tailored to individual needs and offer the highest level of hygiene and comfort for guests. Installation of the Sensia Arena also serves as one of the Château's solutions towards their environmentally conscious efforts. Meurin explains why he chose GROHE and how he can't imagine a modern hotel choosing to go without the Sensia Arena.

Le Château de Beaulieu is located in Busnes in the north of France.

GROHE

First of all, how did you discover shower toilets?

Marc Meurin

I discovered shower toilets during a trip to Japan. I was reluctant to use them at first, but ended up trying out the shower toilet experience after a few days. From the first time I used it, I was convinced by the product and by the sense of hygiene that it offered. Using a shower toilet quickly became an inevitable choice.

G You've ordered GROHE Sensia Arena toilets for your hotel – why did you place your trust in GROHE?

MM **GROHE is a renowned brand that is recognized for the quality of its products – currently all the hotel's bathrooms are fitted with GROHE faucets. I am particularly attached to the brand's reliability. So we immediately thought of GROHE when we wanted to renovate the hotel for its 10-year anniversary. When GROHE offered to**





install Sensia Arena shower toilets, I seized the opportunity to enjoy a quality product that was innovative and affordable. The GROHE products' durability and reliability made the decision easy for me.

G Which of the GROHE features did you find attractive? What convinced you that Sensia Arena was the right choice?

MM To me, Sensia Arena is an innovative product that provides a total sense of hygiene. This reflects the spirit of the hotel, as over the past several years we've sought to commit to behavior that is more environmentally friendly, based on waste recovery and energy savings. The Sensia Arena shower toilet is fully functional and customizable, and this is another one of its strengths: it's good to be able to use the drying function and to adjust the intensity of the jets and the water temperature.

G How was Sensia Arena received by your clients? What were their reactions?

MM Even though most of our patrons had nev-

er tried a shower toilet before, we've had extremely positive feedback. One customer told me she was very impressed and that it would be a major factor in returning to our establishment! That said, Sensia Arena doesn't just appeal to grown-ups – children also had positive things to say about it. I think that customers who have tried Sensia Arena here will eventually end up adopting it at home, as I find it difficult to return to using ordinary toilets after using a shower toilet. And for anyone who is still apprehensive about using the product, Sensia Arena does still allow you to enjoy the features of a more traditional toilet.

G How long have shower toilets been installed at the Château de Beaulieu? Are you satisfied with your choice?

MM The hotel has had six Sensia Arenas for the past two months, and I am very satisfied with them, as are my customers. Ultimately we want to have the entire hotel equipped with them – I have already ordered 18 additional shower toilets! I am convinced

The hotel's restaurant, Le Meurin, has garnered two Michelin stars.



Pure Freude an Wasser



Le Château de Beaulieu has 24 Sensia Arena shower toilets, combining convenience with perfect hygiene.



that installing Sensia Arena shower toilets will be a positive investment for my hotel. It allows me to set myself apart from the other establishments, thanks to an innovative product that combines convenience with perfect hygiene.

G Finally, would you recommend Sensia Arena to your colleagues in the hotel business?

MM Yes, I've been so satisfied with GROHE's shower toilets that I had a Sensia Arena installed in my home not long after we had them installed at the hotel. I'm also considering having one put in my second home. Above all, this is because today I can't imagine going back. The change is so radical and satisfying that you end up asking yourself how you ever managed to have personal hygiene before. I think it's important to adapt our behavior to the innovations of our time. In my opinion, it would be a mistake to renovate one's equipment without replacing the existing toilets with shower toilets. But then, perhaps there are still people out there who would buy a black-and-white television?



Presenting the iconic virtues
of the redesigned Atrio faucets.

PRECISELY ELEGANT

PHOTOGRAPHY: ATTILA HARTWIG
STYLING: MARINA MELENTIEVA



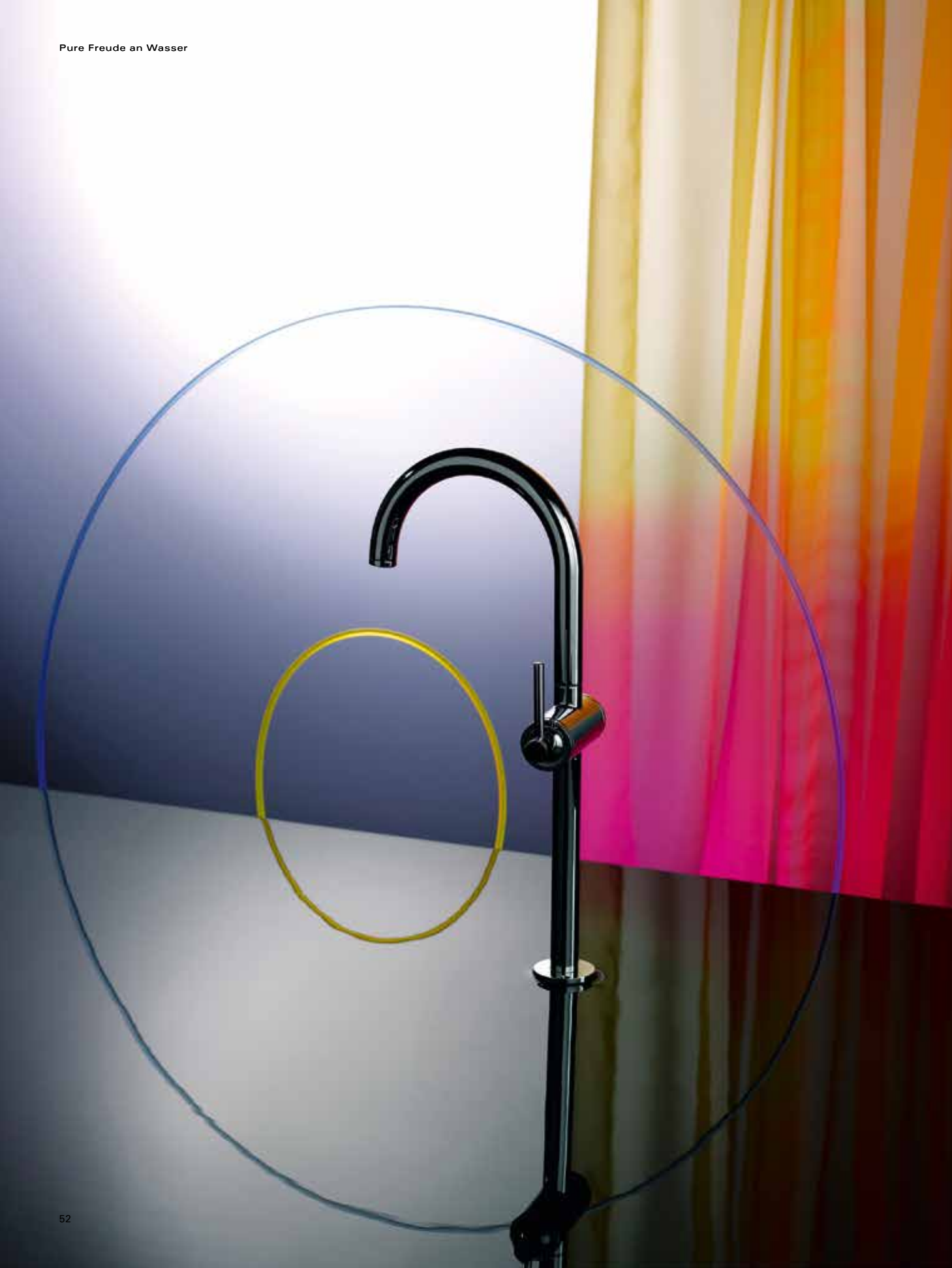





RE-CRAFTING AN ICON

GROHE Vice President of Design Michael Seum talks about revisiting a classic, challenging the engineers, and creating an icon in the new Atrio.

Redesigning a classic is a task not to be taken lightly. It's a design opportunity that involves walking a tightrope between respecting the past and opening oneself up to contemporary ideas. GROHE's Vice President of Design Michael Seum, however, was delighted to step up to the challenge with the classic GROHE Atrio faucet. It was, he says, an exciting opportunity to build on the strengths of this GROHE icon while giving it a feeling of timelessness.

GROHE

What was the idea behind the new Atrio?

Michael Seum

For me, the very definition of an icon is something you can draw from memory. We are calling this the icon of elegance and precision. The elegance is drawn from a single circle, or a cylinder ring, which is one of the most feminine geometrical features you can find: pure and perfect. It's a firmly contemporary design, but with the right interior decor strategy, it could fit in a classic or cosmopolitan environment. Because we've used such a simple, singular geometry, the precision has an analogue, tactile feel to it. So much of this world is digital and uber-connected that we felt like for our spa collection, we needed to have this tactility. And it's done in such a way that even when you look at the design, all of the intersections are precise. Nothing is off-center.

G How is this driven by the technology that's inside, like the cartridges?

MS The quality of the design comes through the craftsmanship and also the precision of our high-quality cartridges. There are three principles that we drew from: the cylindrical element that drives the entire line, an absolute pure intersection of all these geometries, and lastly, the obsessive attention to proportion. We wanted a design that celebrates the quality of the GROHE cartridge – it's the perfect expression of our design DNA.

G Also it's a very slim cylinder – that makes it elegant for me. How long have you and your team had been working on this, from the first sketch to now?

MS We had a discussion about the possibility of having the spa geometry perfectly intersect, I think, about 18 months ago. While we came pretty quickly to the idea, the execution was actually the hardest part of the job; getting the engineering team to find a way to do that.

G So really this was something that was sparked by your team, and became a collaborative effort – what challenges did you have to overcome with engineering?

MS The engineers saw the potential of the design. But they also saw that it was their responsibility to help us realize it. So I'm really pleased at how they've embraced the design vision and made all of the technical elements work, going through such meticulous, geometrical work with the Atrio. This is where the precision comes in. All of the tactile feedback, the craftsmanship, the quality, the handmade aspects – it's all due to their efforts.

G How has the feedback on this product been so far?

MS We've had some sneak previews with a few long-standing customers and architects that we have very positive relationships with. We do a lot of work on projects that are two to five years – big architecture projects – and the response when we put this on the table is just jaw-dropping. It really is iconic, it's beautiful, it's flexible, and it's simple. We designed something that allows architects or consumers to design spaces in so many different ways. The fact that the product is so simple means that it can work with different interior strategies. They see that immediately.

G What plans do you have for the Atrio in the future?

MS We will launch it in Spa Colours over time. Because this design is so neutral, we believe that this is the vehicle for expressing new color and finish possibilities in the bathroom. It's a design that works in so many different environments, from classic to contemporary and cosmopolitan. It has this transformative effect in those spaces.

INTERVIEW: GABRIELLE COX



The new Atrio was designed with an obsessive attention to proportion.

*Pure Freude
an Wasser*

GROHE
WAVES

THE ICON OF ELEGANCE AND PRECISION

GROHE ATRIO



Consider the circle. A staple of natural geometry. A pure form at once soothing and dynamic. A visual metaphor for both completeness and eternity. For its new Atrio collection GROHE draws on this most elemental and elegant form to create an iconic object that is built to last. [grohe.com](https://www.grohe.com)

KNOWLEDGE TRANSFER



With a perfect synergy between Japanese and German teams, GROHE and LIXIL have made some astonishing technological breakthroughs.

INTERVIEWS: GABRIELLE COX

Two brains are better than one. Since GROHE joined LIXIL's portfolio of brands, minds from different departments have come together to create a lineup of popular new products. Here we talk to two teams who have collaborated on the GROHE Sensia Arena toilets and the GROHE SmartControl device, which has integrated a technology called the »Push Valve.« The teams describe to GROHE Magazine the challenges of developing technologies for the European market as well as the gratifying experience of working together.

SENSIA ARENA

GROHE

Which department do each of you work in and what technology have you been working on?

Yuji Nakayama

I work in the Global Shower Toilet Business Department and, since joining LIXIL 15 years ago, I have been working on Ceramics and E-bidets (spalets).

Horst Bachmann

I'm working in the TDC Department – short for Technical Development Ceramics. We have been working together with the Japanese team to utilize their Japanese shower toilet technology and transfer it to the European design.

G Could you please describe the technology you developed? What problems were you trying to solve?

YN I developed a thinner E-bidet with a lower height than those usually sold in Japan because I wanted to provide the German market with a more sophisticated design.

HB The challenge for the whole team was to get additional hygiene features and functions installed into the already very low E-bidet part of the toilet.

G What were the discoveries, how did you make it work?

HB We wanted to use several components from the super successful Japanese Satis shower toilet, but also add technologies such as the Plasma Cluster. For that we had to change the design completely. From the outside it's hard to see that Satis and the Sensia Arena are based on the same technologies.

YN To solve the issue of space and size, I tried to place as many E-bidet parts as possible inside the ceramic body. We changed the structure and engineering; for instance, the thickness of seat, the position of the sensor, the layout of the components, and modified the shape of some parts.

G What are the hygiene benefits of the Sensia Arena?

YN The shower functions and the auto open and close function offer consumers a clean, hygienic experience after using the toilet. Sensia Arena also has anti-bacteria and anti-dirt functions on its ceramic

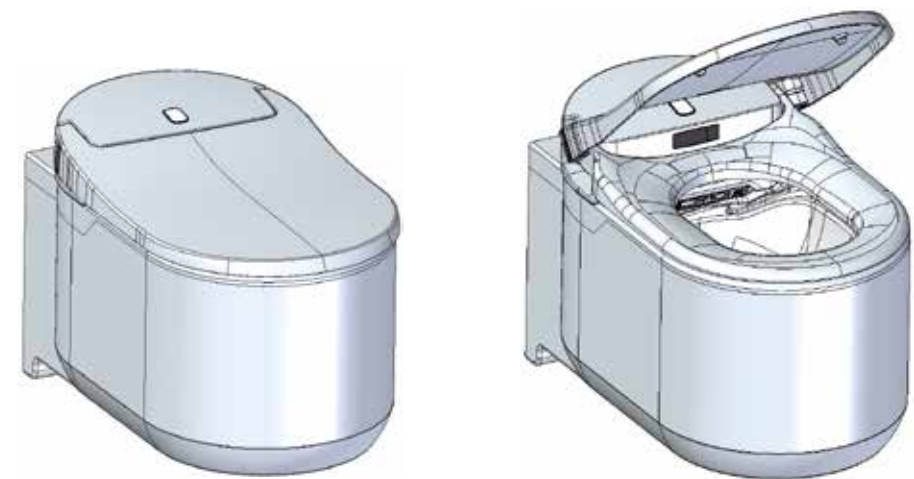

GROHE's Sensia Arena uses many components from the successful Japanese Satis shower toilet, yet the team of Japanese and German engineers decided to change design completely.



Adapting the Push Valve technology for a thermostat, GROHE SmartControl, allows the user to control both the temperature and the water flow in one operation.

surface, called AquaCeramic and HyperClean, which reduces the frequency of cleaning required compared to traditional toilets.

HB In addition to AquaCeramic and HyperClean, the Plasma Cluster operates on demand and kills bacteria and prevents its growth on the surface of the ceramic bowl, the surface of the seat, and under the lid where the flush water cannot wash.

G Tell me about the collaboration between the two teams.

HB For me, it was quite a challenge to convince the Japanese team to modify their very successful products for a European market, especially after they've collected product insights over so many years. But, I think the collaboration made us much more efficient in developing new innovative features, and I'm proud of the products we designed together.

YN Well, I really respect my German colleagues because they always pursue ideal targets. Japanese often think from the perspective of ›What can they do?‹ whereas most German colleagues usually think ›What should they do?‹

G What achievement are you the most proud of?

YN As the Arena project lead, it's very gratifying that the design has received 14 awards and has contributed to the growth in the market share of the shower toilet in Germany.

HB I'm proud that we made a toilet that kills bacteria and prevents its growth in all areas! That's a huge consumer benefit and it makes me happy to have achieved that. But ultimately between us we have created a GROHE product that is fast becoming a category leader in Germany only a year after its launch. That's quite an achievement!

SMARTCONTROL

G What technology have you been working on in your respective departments?

Naokazu Onishi

I'm head of the Push Valve project. I was assigned to the Faucet Division to create a synergy with GROHE, after 15 years of working on the Flush Valve for residential toilets.

David Mainka

I'm also working on the Push Valve, but in GROHE's R&D Showers department.

G Could you describe the technology you developed?

NO Push Valves – a cartridge technology that enables the user to carry out two operations at the same time – have existed for about ten years, but they were only used in bathroom faucets as thermostats.

DM We discovered that it could also be used in thermostats so that the push valve cartridge can preset the desired flow for each outlet and is activated by a sin-

gle press. By using the Japanese Push Valve technology and integrating it into the SmartControl thermostat, we have created a whole new way of showering that puts choice into the hands of the user.

G What challenges did you have to overcome together in order to succeed?

NO Push Valves had only been used with the water here in Japan, which is soft because it has a lower mineral content. We found out it would easily malfunction if used in Europe, because the water is much harder. We realized there was no way to avoid the effect of hard water, no matter what shape the path of the pipe was, so we needed to modify the structure to create a mechanism that could clean every move.

DM Yes, making the Push Valve comply with GROHE requirements posed a problem because we didn't want to change the basic concept and components of the Push Valve. It took a lot of testing in the GROHE labs. So the GROHE R&D Team developed a cleaning pin, which was so successful that it's now patented. We also modified the geometry of the mating part so that a membrane could seal properly, even in hard water circumstances.

G How is the pin used in SmartControl and what is the consumer benefit of the SmartControl shower system?

NO The pin is located in the main body of the SmartControl, in the valve that controls the on/off operation and volume control of the shower.

DM The on/off operation is hugely innovative – not only does it start the shower, it allows you to choose the spray intensity of each single outlet of GROHE's SmartControl shower system. All you have to do is rotate the smart control lightly.

NO Also, the valve has a feature that allows you to set different volumes for each button, so different flow rates can be set for a ›Hand Shower‹ and an ›Overhead Shower.‹

G In retrospect, which achievement are you each most proud of?

DM I think that adapting Japanese technology from one product category and using it to create a brand new one is a real innovation that we can all be very proud of.

NO This was the very first product GROHE and LIXIL collaborated on, so I am very proud that we overcame many challenges and paved the way for future collaborations.

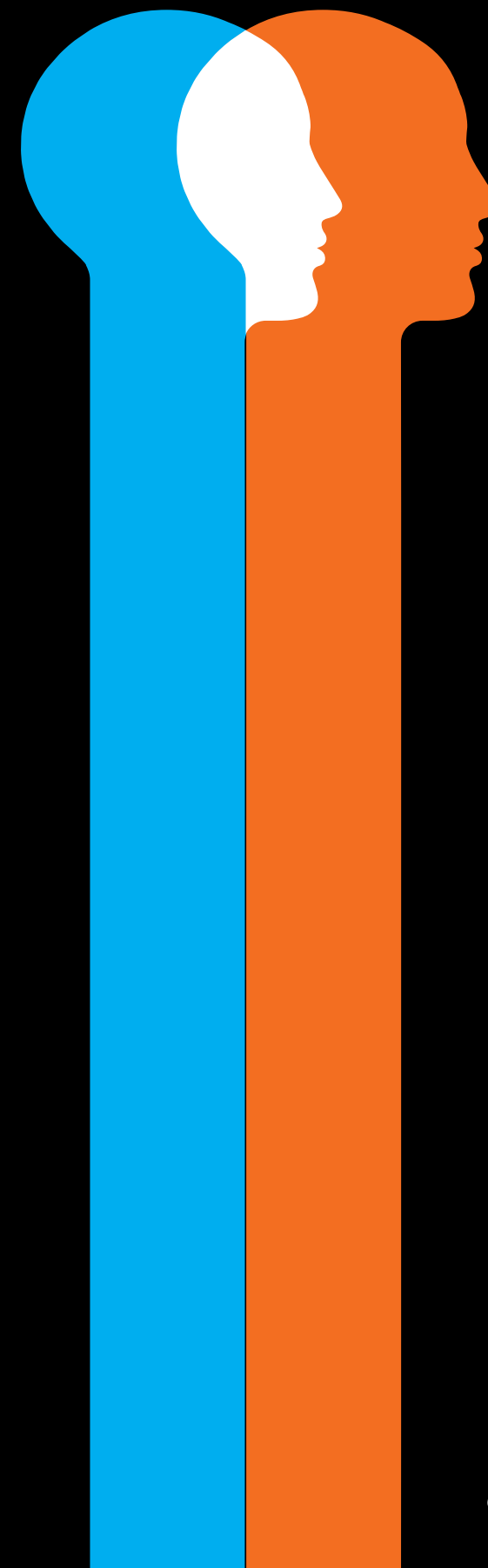

BEST OF TRENDS

Which trends are heating up and what's cooling off? GROHE's Design Team delivers all the interiors insight for 2018 including their picks of tough industrial pieces, leafy green looks, and recyclables, where optical illusions, muted palettes, and polished surfaces thrive.



Glass

Rethink the home as more of a glass menagerie: a constant source of fragmented light and a reflection of all those ever-so-carefully selected tastes. And now, this includes your taste in scent, since **Laboratory Perfumes** have been reinterpreted by **Zuza Mengham** in these angular capsules that look like they've been hacked out of a precious stone. Each represents one of the perfume collection's aromas: Amber, Gorse, Sapphire, Tonka, and Atlas.

Industrial

Jaw-dropping warehouse conversions are no new concept to the architectural community, yet industrial design's clutch over trends is still tight, with durability and streamlined shapes still making waves. **Artifact** have built their pendant lamps to evoke a nostalgic softness, inspired by vintage railway lighting: a fitting punctuation for minimalistic environments.



Terrazzo

Terrazzo, with its chipped rocks set in concrete, usually triggers images of Mediterranean monochrome flooring, those mass-produced creations spun from hydraulic-powered grinders before being polished to infinity. Here, a Scandinavian offering, from **Örn Duvald**, signals the arrival of a more sentimental approach to the material, with their **Danish Local** bench, made from the same concrete and water mix found everywhere in Denmark.





Pastel

Handsome, muted tones from auburn to ocher have long satisfied a desire for a palette beyond the monochrome, but this year sees a shift into a bolder embrace of pastels. **Deadgood's Scaffell** three-seater is a nod to England's most majestic summit, and its sweet but subdued coral injects character into an otherwise functional spectrum.



Waste

They say one person's trash is another's treasure, and **Kizis Studio** is truly taking this phrase to heart in the sleekest fashion. The **Artichair** derives its name from its material of choice: the abundantly available, ancient Mediterranean artichoke thistle, sanded and polished for your sitting pleasure.

Botanical

As appetites for sustainable designs grow, so do the options for dropping botanical details at home. Thanks to **Cole & Son**, you can now bask in the fronds of their **Palm Jungle**, a lush and emboldened celebration of the verdant outdoors.



SPARKLE & FADE

Artist and activist Courtney Mattison uses colorful contrasts in her larger-than-life coral reef imitation installations, highlighting how far ocean damage has gone.

TEXT: ALEXANDRA PEREIRA



Artist and activist Courtney Mattison focuses on raising awareness about endangered coral reefs.

A lucid coral reef of fleshy reds, highlighted by sage and emerald greens, is surrounded on all sides by deathly-white skeleton corals emerging from the surrounding midnight-blue abyss. Courtney Mattison, an artist and activist from San Francisco, had an early fascination with these beautiful underwater ecosystems, which she renders in her larger-than-life ceramic imitation-coral installations. Her fixation on these rich-hued kingdoms is not just for their beauty, but for their somewhat treacherous, exhilarating nature, as she puts it: »I love coral reefs for being exotic, diverse and often venomous.«

For subject matter so colorful, it's a serious subject that Mattison has concerned her career with, since in real life, this lively coral is deeply threatened by ocean pollution, such as our reliance on non-recyclable plastic for bottles and packing materials. In a bid to save those beautiful colors from bleaching out, the self-proclaimed »artist« transposes her marine biology background into her fine sculpture work, which has been making waves in the worlds of science and alike. Mattison's chosen material is ceramic, using calcium carbonate (which coral is also made out of) as an ingredient in the



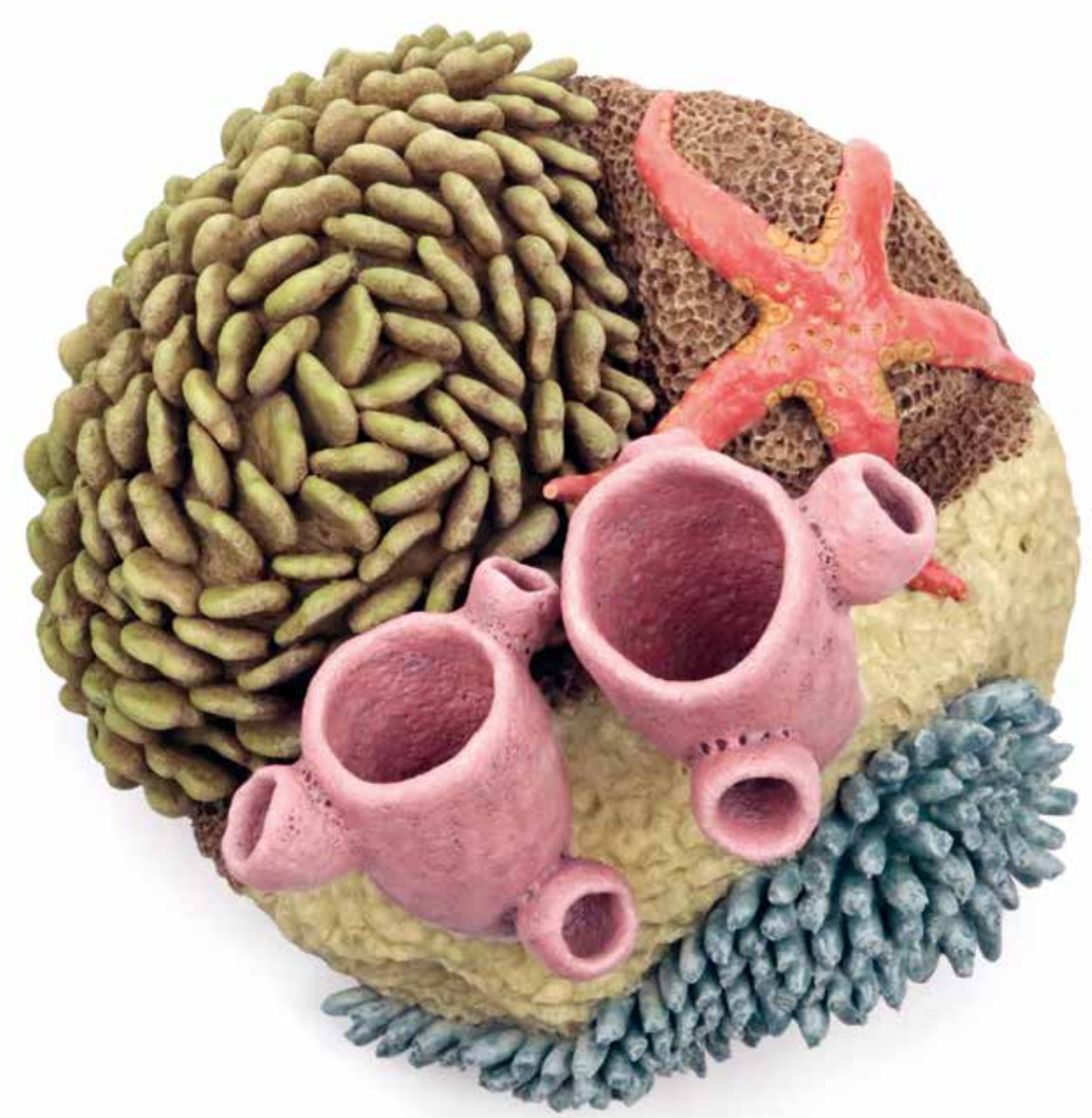

Mattison makes her works out of ceramic and includes calcium carbonate (which coral reefs themselves are made out) in the glaze.

glaze, which becomes brittle when used, imitating the tiny, intricate coral branches.

Mattison is not the only artist exploring underwater spaces as both sources of inspiration and activism, as well as backdrops and canvases. For example, Celia Gregory, a British artist who works with mosaics and 3D technology, created an underwater sculpture park in 2016. Surrounding her wonderland, on the actual land, was an eco and wellness festival that included talks and workshops on damaged biospheres and ocean research, while guests could also snorkel or free-dive around Gregory's work and take in the emotional impact of her submerged garden. This is also echoed in her work »Belize Sea Goddess,« which she erected underwater during National Reef Week at another marine reserve that summer.

»I love coral reefs for being exotic, diverse and often venomous,« says Mattison of her underwater fascination.

Sometimes you have to see things to feel them, in the same way that nature documentaries pair awe-factor with resounding sadness. The work of an activist like Mattison follows that of pioneers such as photographer Spencer Tunick, who also makes site-specific projects that challenge and provoke the onlooker to become more socially



In a bid to save coral reefs from the dangers of pollution, the self-proclaimed »artist« transposes her marine biology background into her fine sculpture work.

and environmentally concerned. It makes perfect sense then, that Mattison's master's thesis sought »to create a monument to the plight of coral reefs to advocate for environmental stewardship and policy change.«

The result of this thesis was an unsubtle, if considerate, aggressor; an exquisite coral-reconstruction installation entitled »Our Changing Seas I: A Coral Reef Story« (followed in later years by »Our Changing Seas II and III«). Towering at almost five meters high and more than three meters wide and weighing over 680 kilograms, its presence was affecting. Great slimy algae and blossoming red coral merges into damaged, bleached imitation reef as an imposing representation of recovery and dread, or, in the artist's words, »a sense of hope for recovery, reflecting my interview participants' insistence that hopeful imagery would inspire more action than portrayals of doom.«

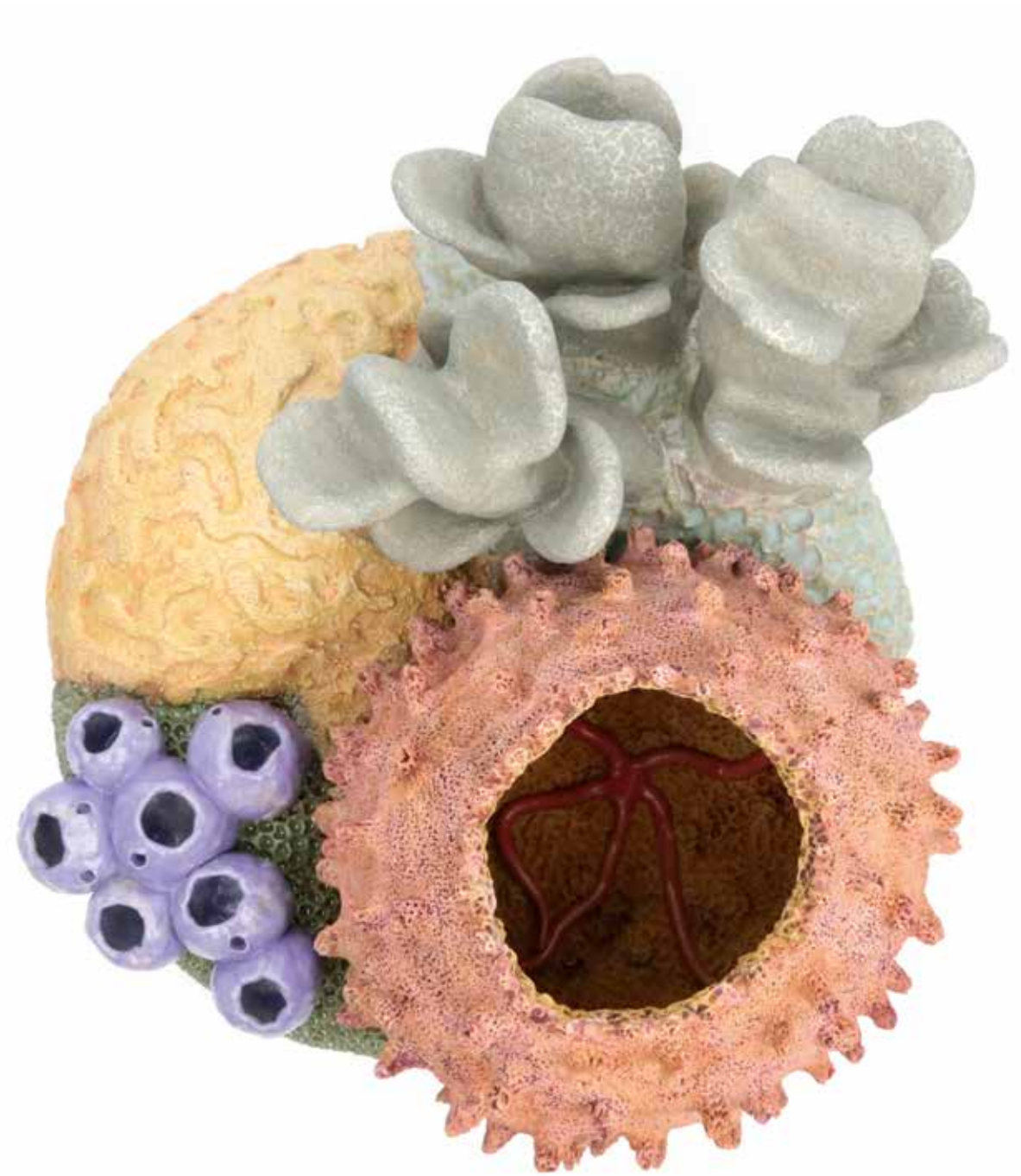

Mattison follows pioneering artists such as Spencer Tunick and Celia Gregory.



LEARNING FROM AFRICA

Designer, urban researcher, and mastermind of an award-winning school that floats on water, Kunlé Adeyemi is an architect whose work spans disciplines and continents.

TEXT: JOSIE THADDEUS-JOHN

There isn't much that Kunlé Adeyemi doesn't do. A lecturer, architect, furniture designer, and urban researcher, he is interested in any way to engage with the concept of the city, especially as related to the global South and developing countries. In particular, he is interested in bridging the gaps in infrastructure to create networks and exchanges that work for the people who use them. From his planning and architecture work in the sprawling hub of Lagos, Nigeria to more high-profile designs such as the inverted neo-classical form of his 2017 iteration of the Serpentine Summer House, the goal remains the same: »Whether a chair for charity in South Africa, a revolutionary rotating art space for Prada in Seoul or the visionary plan to eliminate traffic paralysis in Lagos with the 4th Mainland Bridge, in each project the essential needs of

performance, value, and identity – critical for success – are fundamentally the same for me.«

Adeyemi has always been interested in architecture. Following in his father's footsteps, he designed his first building as a teenager, and went on to work at the legendary studio of Rem Koolhaas, OMA (Office for Metropolitan Architecture), where he helped to realize projects such as a giant rolling pavilion in Korea for Prada, an odd geometric cross between a tent and a four-sided die.

However, since starting up his own Netherlands-based office, Adeyemi has become mostly associated with a specific movement in architecture, one that uses water as its foundation. Floating architecture has been a hot topic in city



At the Black Rhino Academy, Kunlé Adeyemi proposes a live-learn space within the nature of Tanzania.



planning in recent years, since it offers invaluable »blue space« to architects in urban centers that are dealing with overcrowding, yet full of waterways. As water levels rise internationally due to global warming, coastal communities that are under threat of flooding are taking their homes onto the water, moving with the changing tides rather than against them. This has specific interest for cities in the developing world, as rapid urbanization coincides with the challenges of climate change.

This was the impetus behind Adeyemi's award-winning project, the Makoko Floating School in Lagos. One of his studio's flagship projects, it was constructed in the Nigerian capital's informal lagoon town on the water. A triangular profile was constructed out of locally

sourced wood and added to a flotation platform that keeps it above water. The structure's three stories offered not only a school, accommodating pupils who were previously only served by a single school in a flood-risk area, but also an adaptable space that could function as a community hub, health center, or market, according to need. »We are just starting to brace ourselves and learn to live with water as opposed to fighting it,« Adeyemi said of the project, which marked a turning point for the Nigerian government's attitude to the unofficial settlement at Makoko: once the project was confirmed, Lagos authorities backed away from their previous plans to demolish the area. As well as winning the 2013 ar+d Award for Emerging Architecture, it was nominated for the 2015 International Award for Public Art, among other accolades.

For his Serpentine Pavilion, the architect and researcher inverted the internal space of a neoclassical building.



Adeyemi's final design for Chicoco Radio includes a mast that cantilevers a bridge down into the water.

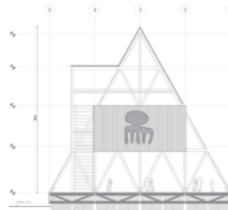

Three stories tall, the school offered an education space as well as a community hub for local residents.

Now based in the Netherlands, undeniably the world capital of floating architecture, Adeyemi is nevertheless committed to bringing Dutch and European aquatic insights to developing countries, as well as utilizing urban strategies that can be gleaned from an African urban context. Adeyemi continued his work on buoyant buildings further down Nigeria's coastline, this time with Chicoco Radio, a floating media platform in the Rivers State capital of Port Harcourt. Again, the building used entirely locally sourced materials and is run, owned, and operated by the area's residents. This integration into the population was crucial to Adeyemi and his team, who spent a number of years on the process of discussion and focus groups to ensure stakeholders' needs were met. The final design includes a mast that cantilevers a bridge down

into the water, a gateway between residents' past on land and their future on water.

Despite these H₂O-friendly structures, Adeyemi is at pains to point out that his practice is not all about floating architecture. »That's not what my practice is focused on,« he told Copenhagen's Louisiana Museum of Contemporary Art. »It's really the relationship between water and the city, between water and humans.« In fact, his CV shows that he is equally committed to all kinds of public space. One of his projects currently under construction is The Black Rhino Academy in Karatu, Tanzania – a primary and secondary boarding school campus that is conceived as an immersive experience for learning from nature. With three different »islands« (dedicated to »play,« »living,« and »learning«),



the wild open nature offers a protected yet free place for young minds.

Adeyemi's commitment to solving the conceptual and practical issues in a global, urbanizing world has earned him high praise from the architectural community. For 2017, he was named the Aga Khan Design Critic in Architecture at Harvard University Graduate School of Design, one of his many academic contributions, and has served on the jury of prizes for the RIBA and AIA. Moreover, the Makoko Floating School's second incarnation – the MFS II – won the esteemed Silver Lion at the 2016 Venice Architecture Biennale. This second iteration is now the only remaining version – the original being a prototype and luckily out of commis-

sion after it was unfortunately destroyed in heavy rains in 2016. This storm only proved the precarity of building in a place susceptible to a changing climate. Its abrupt collapse showed the importance of an ongoing investment that learns and develops as it goes along. »The innovation of Makoko Floating School came not only from us, but largely from the community itself,« Adeyemi told Architectural Digest. »We were simply agents to compose those ideas into a new form or an improvement of what's already existing: the architects of the future will begin to be seen more as agents of change.« No matter which way the wind blows, and whether the tide is in or out, it's Adeyemi's sustainable focus on community development that gives his ideas real staying power.

For the Makoko Floating School, a triangular profile was constructed out of locally sourced wood and added to a flotation platform that keeps it above water.





The Makoko Floating School's second iteration - the MFS II - won the esteemed Silver Lion at the 2016 Venice Architecture Biennale.

PORCELAIN DREAM

Alexis Christodoulou's imaginary geometries provide the perfect virtual set for GROHE's Ceramic lines.



Like something out of a dream, the Bau range comprises perfectly intuitive products that are available as a full bathroom solution.



The Cube line keeps your bathroom in line with its geometrically precise angles.





With the GROHE Euro Ceramics range, any bathroom can find a balance between luxury and simplicity, contemporary elegance and traditional style.



Despite avoiding competitions, Laird Hamilton is one of the most famous big-wave surfers in the world. We spoke to the aquatic aficionado about a new critically acclaimed documentary film about his life and dedication to keeping the ocean clean.

WATERMAN

TEXT: DELPHINE SAINT-JEAN



Carving through huge waves is Hamilton's speciality: he's known for surfing »the heaviest wave ever ridden« at Teahupo'o reef in Tahiti.

Born in 1964, Hamilton is one of the world's most famous big-wave surfers, despite avoiding competitions.



As Laird Hamilton glides on his surfboard along a breathtakingly tall sheet of water, it's hard to imagine what he might be thinking. Regarded in the surfing community as one of the all-time best at big-wave surfing, he's tackled some of the most monstrous waves in the world, and always has an insatiable appetite for more. How does he do it, approaching this uncontrollable force that could snap him in two at a moment's notice? »The ocean is my home,« he says, simply.

Born in 1964 (in an experimental, saltwater sphere in San Francisco – where else?), his mantra is never to let an opportunity pass him by, a motto that has now been immortalized in a documentary of his life, »Take Every Wave,« directed by the Oscar-nominated Rory Kennedy. The film follows his career and personal life through crests and troughs, beginning in the present day of 2016. He's shown on Kaua'i island, looking longingly out at the terrific swells created by El Niño, before rewinding to the earlier days of his career – notably his legendary, miracu-

lous surf over the »heaviest wave every ridden« at the notoriously hazardous Teahupo'o reef in Tahiti.

Hamilton is pleased with how the film has been received so far: »The critics have been nice, let's just put it that way,« he tells GROHE magazine. What's noticeable about the film is its transcendence of the surf genre and its focus on creating an intimate portrait of Hamilton and his wife Gabrielle Reece, a professional volleyball player and model. »Once [Rory] Kennedy and her husband Mark got involved, they wanted to do something more personal about my life,« he explains. »I wanted to get the film as much of a chance to have an impact as I could. They're the storytellers so I followed their lead.« Hamilton is by now accustomed to being in front of the camera, and not just when he's carving white trails into glassy blue waves on his surfboard. Being model-spotted on the beach at Kaua'i at 16 led to shoots for Italian Men's Vogue and a spot in front of the camera next to Brooke Shields. He's also appeared in a



Hamilton is also the co-inventor of tow-in surfing, which allows surfers to get onto even bigger waves.

variety of films, both as himself, such as in the giant-wave surfing documentary »Riding Giants,« and as a surfing double for Pierce Brosnan in »Die Another Day.«

»There are a lot of pieces to living a fulfilled, happy life.«

Indeed, there's something of the 007 agent about Hamilton – his fearlessness, his capacious talents, his calm in the face of literally insurmountable obstacles – and yet his attitude to life is much more meditative than Ian Fleming's immortal character. »There are a lot of pieces to living a fulfilled, happy life. It's like the spokes of a tire: you need all the spokes to be nice and firm so that the wheel rolls well,« Hamilton says.

Which brings him, always, back to the big blue: »I've been fortunate to not let the influence of peer pressure stop me from pursuing the pure feeling of riding a wave and maximizing my relationship with the ocean.« And this is partly because he has chosen a more holistic approach to riding waves than competitive surfing tends to encourage. Eschewing big prizes, he's more interested in exploration and the deep connection of aquatic achievements. »My relationship with the ocean comes out of a more artistic and philosophical approach than what would be normal if you were trying to be a surfer.«

This attitude was informed by his upbringing in Hawaii, where he grew up with his mother and adoptive father (also a surfer), where traditional island attitudes to the ocean profoundly influenced him. »The Polynesian culture itself has influenced my life. I think when you grow up on an island, if you don't have a relationship with the ocean then you're probably in prison – I feel close to the essence of it: the exploration aspect of it and the relationship with nature.«

Despite his insistence on the natural aspects of zooming through the pipeline, he has also spent much of his career innovating and finding new ways of using technology on



»The ocean is my home,« says Hamilton, star of the critically-acclaimed documentary »Take Every Wave«.



the water. In particular, he co-invented tow-in surfing with two friends, using inflatable boats to help them reach those waves which were simply too monstrous to get inside of with paddle power alone. He has also been a big proponent of foilboarding, where he uses hydrofoil technology to power the board, and allowing the surfer to use the power of the swell to pull the board into the wave. But is there a dissonance between these two approaches to the water, the technological and the natural? Hamilton thinks not: »All of these crafts are just ways to further your relationship with the ocean and be able to use it. If

you want to be a purist and say »I'm only going to make a wooden tire,« don't expect to go very far with it!« Ultimately, the big-wave junkie is interested in pushing the limits of what is possible: bigger, better, faster. »Foilboarding allows you the freedom and ability to use the wave's energy unlike anything that we've ever been able to up to this point.«

One aspect where he is resolutely on the side of nature, however, is looking after the ocean environmentally. For example, he is a part of the Project Zero movement, which aims to bring together the disparate interests invested in

maintaining the precious resource that our oceans represent. »A lot of the environmental stuff is pretty fractionalized, and so to create a unity and an understanding of what is the priority is probably the more important thing,« he says. »It's part of what I can do the most effectively, to get more people to not only appreciate and admire the ocean and what you can do in it, but also to participate in activities in the ocean. Because then we'll have a bigger voice and we'll have more impact.« And if there's one thing Laird Hamilton wants from the world, it's bigger, better, and brighter.

BUILDING CULTURE

TEXT: GABRIELLE COX

Berlin and neighboring Potsdam are home to more than 180 museums. GROHE Magazine presents three recently opened architectural gems – from high-culture landmarks to a newly knighted street art hub.





The washbasins in the Museum Barberini are fitted with the electronically activated GROHE Euroeco Cosmopolitan E faucets.

MUSEUM BARBERINI

At last, one of Potsdam's shining architectural gems receives a renovation.

Potsdam has always been nostalgic for its Baroque, Rococo buildings that were effectively destroyed during and after WWII. One such building was the Barberini Palace, originally built in 1772 on the bank of the Havel, which, in 2017, reopened as an art museum with the same name. Often, the tough part of architectural reconstruction of these traditional styles is to approach the building with a thoroughness that reflects the rich detail of its original form. This was the daunting task of architect Thomas Albrecht, partner of Hilmer Sattler Ahlers Albrecht architects. Luckily, due to the many documents and visual footage of the building before and after its destruction, Albrecht had a clear template of the venerated building to draw from: »You could count the layers of bricks, so we were certain of the dimensions!«

But his responsibility extended beyond the building's perimeter, since the Barberini also

represented part of a wider project to reinvigorate the area, Albrecht explains: »The reconstruction of the Barberini was also interesting because it complements the other buildings on the Old Market Square: the restored City Palace, the renovated St. Nicholas Church, the Old City Hall, and the obelisks. It is now possible to experience the fascinating dynamic of the square once again.« And of course, even a retired palace needs palatial bathrooms, but in 21st century style. To achieve this, the washbasins in the Museum Barberini are fitted with the electronically activated GROHE Euroeco Cosmopolitan E faucets, which deliver cold or premixed water at the desired temperature. Using an infrared sensor, water flow is controlled completely contact-free and stops automatically after the pre-programmed running time, virtually eliminating bacterial transmission between users. Fit for a queen (or even just an art museum visitor).



The Barberini Palace, originally built in 1772 on the banks of the Havel, reopened in 2017 as an art museum.

Photos: Stefan Müller (interiors), Helge Mundt (exterior views)



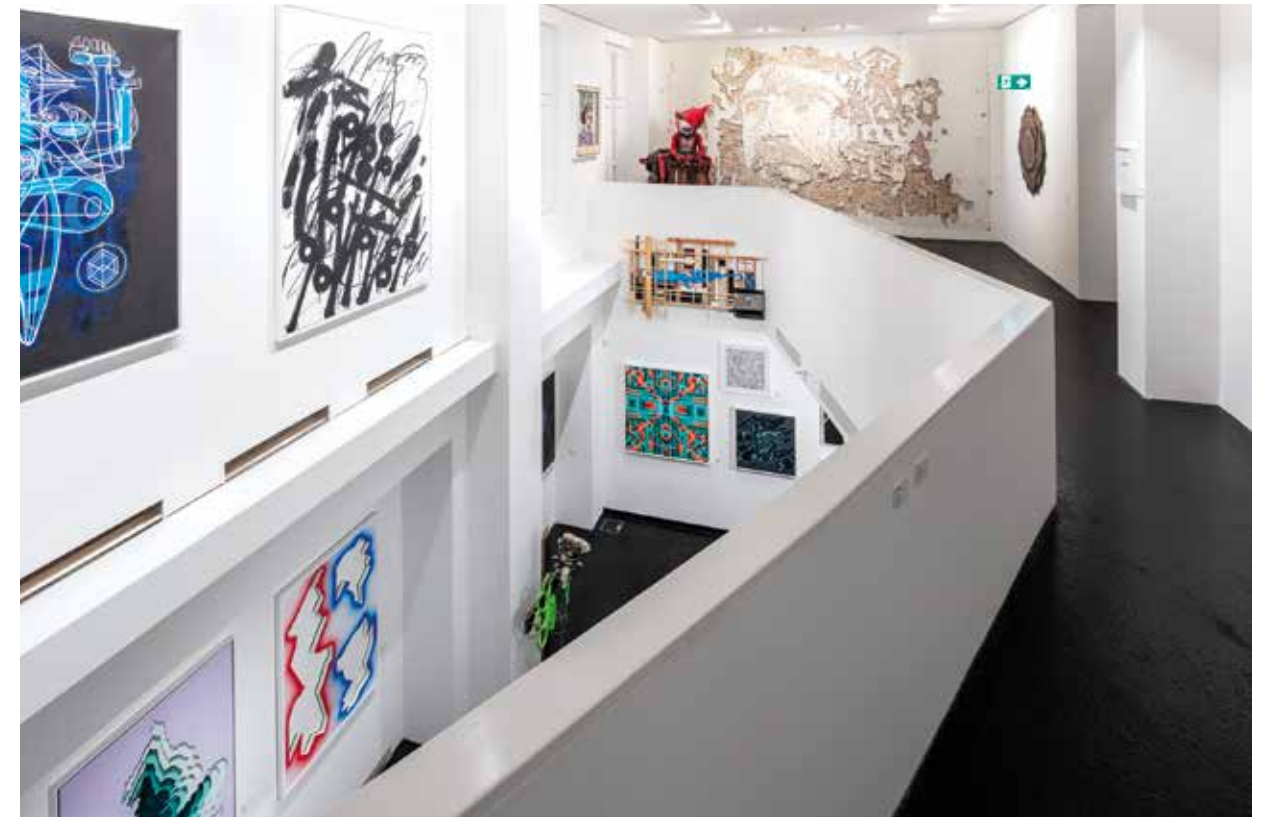

Visitors are able to experience different perspectives on the artworks in the two-floor exhibition area by using an elevated walkway.

URBAN NATION

A shapeshifting platform bringing graffiti in off the street.

The idea of having street art exhibited in a museum context might at first seem like a paradox, but it was a challenge that the architecture innovators at GRAFT welcomed. In order to demonstrate the ephemeral nature of street art, GRAFT converted the front of a five-story *Gründerzeit* building on Bülowstraße in Berlin Schöneberg into a modular façade that's partially interchangeable, so that pieces may be added to the museum's collection or shown at a later date. »It's not temple of art, but an open hub of energy, always ready for change,« explains Thomas Willemeit, one of the founders of GRAFT. »It's about unconventional art capturing its own space and making it possible to rediscover the city. It's about the bridge between art and the city. To achieve this we had to bring the city into the museum.«

Photos: Tobias Hein

The unconventional institution has made a concerted effort to gain acceptance within the urban art community, providing lively opportunities for debate within the scene, and granting freedom to both artists and curators by allowing total possession and flexibility of the space. Within the museum, the entire wall space can be utilized – either through hanging canvases or using the wall directly – and visitors are able to experience different perspectives of the artworks in the two-floor exhibition area by using an elevated walkway. The contemporary design of the Urban Nation Museum extends into the washrooms, where washbasins are equipped with hygienic, contact-free GROHE Essence E faucets. In addition, GROHE's StarLight technology ensures the chrome surfaces are especially resistant to the wear and tear of urban life.



GRAFT's modular façade adorns a five-story building in Berlin's Schöneberg neighborhood as part of their urban art museum.



The modernization of the Staatsoper Unter den Linden includes several GROHE products, which provide comfort to both performers and guests.

STAATSOOPER UNTER DEN LINDEN

Echoes of the past in the renovated and acoustically revamped opera house.

Starting in 2009, the Staatsoper Unter den Linden, and its director's building and rehearsal center, have been undergoing extensive renovation under the careful direction of esteemed architecture firm HG Merz. Fully aware of the building's historical significance, Merz based his work on the design concept of architect Richard Paulick, who reconstructed the Staatsoper from 1952 to 1955, with reference to Georg Wenzeslaus von Knobelsdorff, the original architect. »The Staatsoper is one of the most notable examples of architecture from the rebuilding phase of the GDR, and thus an important witness of German postwar history,« explained Merz. »Paulick's design rectified the transgressions of the imperial era – he made the stage tower smaller and restored the façade to Knobelsdorff's classical form.«

Meanwhile, Daniel Barenboim, the general music director of the Staatsoper, had a more per-

formance-related goal: to improve the auditorium's acoustics. The reverberation time was increased from 1.1 to 1.6 seconds by raising the ceiling without heightening the roof – which was not permissible by urban planning regulations. A reverberation gallery was also added, with a design derived from Paulick's repertoire of forms. The modernization of the Staatsoper Unter den Linden includes several GROHE products, which provide comfort to performers and guests alike. The artists' changing rooms are fitted with Tempesta hand showers and Grohtherm 2000 thermostats, while in the visitors' barrier-free washrooms, the upward-contoured lever of the Euroeco Special faucets make them especially easy to use. Durable and classic, GROHE Eurostyle and Europlus faucets withstand the demands of everyday use in the rehearsal rooms and the stage area: a perfect fit for use by the world's most famous performers.



Architecture firm HG Merz began carrying out the renovation of the Staatsoper Unter den Linden in 2009.

Photos: Marcus Ebener



DESERT WONDER

A fascinating, kaleidoscopic desert vision offers a sci-fi take on a Californian classic.

The typical concept of a mirage is a gleaming, water-filled oasis in the middle of a desolate desert; an imaginary salvation that is filled with as much allure as it is uncertainty. Artist Doug Aitken creates a »mirage« that takes this idea and brings it into architectural reality, with his reflective mirrored ranch-style house that could function as domestic shelter but, from the outside, just looks like endless desert. Appearances shift in the sunlight for the viewer, who can't quite tell whether this is a deception or not.

»We're moving into an era when things are dematerialized and much more holographic,« the Frank Lloyd Wright aficionado explained. »There's really no differentiation between the work I make and the world I live in,« Aitken says of his piece, which was open throughout 2017 in the dusty Southern Californian Coachella Valley. The Mirage house shifts our focus to the virtual, to the invisible, that is always beyond our reach and pays homage to both the realms of optical illusion and mind-bending architecture.



Pure Freude
an Wasser



BEFORE A DRIP
BECOMES A FLOOD.
DETECT TO TAKE CARE WITH GROHE SENSE.

The new GROHE Sense system monitors humidity, detects leaks, alerts you and shuts off water automatically. Enjoy intelligent water security for your home 24/7. [grohe.com](https://www.grohe.com)

THE NEW ATRIO



www.vosoughishop.com