



JUSTIME | 巧時代

SHENG TAI BRASSWARE CO., LTD.  
No.99 Sec.3 Chang Tsao Rd, Ho Me Chen Chang Hua 50841, Taiwan  
TEL: +886-4-7629971 FAX: +886-4-7526980  
E-mail: info@justime.com  
Website: www.justime.com  
Facebook: www.facebook.com/JUSTIME

[www.vosoughishop.com](http://www.vosoughishop.com)

JUSTIME | 巧時代

Floor Drain

2017.03 Floor Drain 04-27071159

JUSTIME

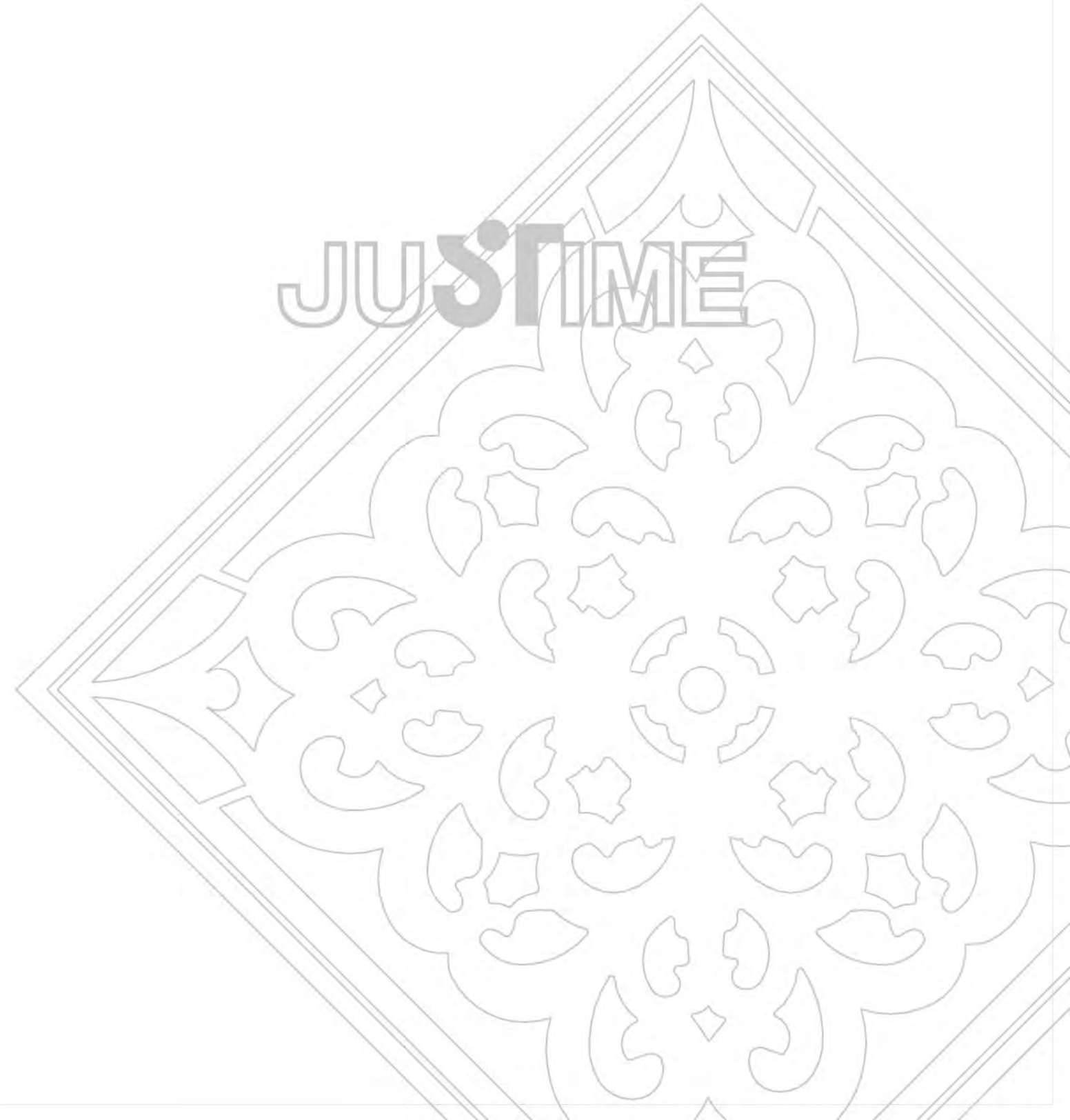

# BACKGROUND



Sheng Tai Brassware Corporation (ST) was established back in 1976, by an ambitious and energetic management team. The strategy at that time was to provide a developing and manufacturing service for customers who demanded excellent design and consistently reliable quality. ST has been continuously developed over the past 41 years, in order to meet the dual requirements of aggressive market growth and a strategy of globalization. A significant investment in a Thailand production facility has enabled ST to move to the global forefront of brassware design and supply for bathrooms.

In order to reinforce its position as industry leader in bathroom brassware, and by means of extensive investment, the Company has installed CNC (computer numerically controlled) lathes, NC (numerically controlled) machines, machining centers, automatic polishing machines, die-casting machines, automatic forging machines, fully-automated electro-plating lines, 3D bending machines, 3D measuring machines, spectrometers and coating-thickness-measuring instruments. Based on the management ideals of reliability, service, quality, style and innovation, ST has been continuously dedicating resources to research and development in production techniques and quality improvement. ISO 9001 quality assurance has long been incorporated into manufacturing processes, with a keen eye on customer satisfaction. Today, ST is proud to provide comprehensive service to customers in global markets – most notably Europe, Japan, the Middle East, Asia, USA and Canada.

Sheng Tai Brassware Co. Ltd. started out by specializing in the development and manufacture of bathroom fittings and related professional products. Later, ST focused on the design and production of a wider expanse of bathroom products, establishing its own brand, "JUSTIME". The JUSTIME brand has attracted major awareness on the international stage, with a reputation for combining high quality with aesthetics from oriental and western cultures. JUSTIME has received honors not only from within Taiwan, but also via international design awards, such as the Red Dot Product Design Award, iF Product Design Award, Chicago Good Design Award, Design Award of the Federal Republic of Germany, IDEA Award and so on. The brand new, fresh designs not only create a fashionable bathing space: they also lead the way in bathroom products of the future.

JUSTIME proposes fine designs and attracts buyers who are looking for unique and novel bathroom ware, with one foot in the present and one foot in the future.



## INDEX

---

Introduction	01 - 06
Brass point floor drain	07 - 14
Stainless steel floor drain with tile insertion	15 - 20
Stainless steel point floor drain	21 - 28
Stainless steel point floor drain	29 - 34
Stainless steel linear floor drain	35 - 40
Stainless steel point floor drain (outdoor)	41 - 45
Drain core type	46 - 46
Stainless steel point floor drain (water sealing)	47 - 51

1. Flow rate increases as the water volume increases.
2. Unique strainer design which prevents hair and any foreign objects.
3. Patented strainer prevents insects and backward water flow
4. Easy to install; easy to maintain.
5. Products are made to perfectly fit in the floor and underground pipe.



Applicable for wet areas



Applicable for dry areas



Material used:  
Stainless steel 304



Easy to maintain/clean



Prevents clogging



Prevents odor/insects/water backflow



Multiple colors available



Resistant to weight



Water flow rate 15L/min



Water flow rate 20L/min



Water flow rate 25L/min



Water flow rate 60L/min



Applicable for public/outdoor spaces



Heat Resistant



Erosion Resistant



Acid Resistant



No Smell

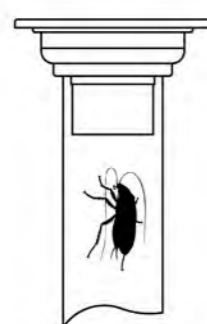

No Bug

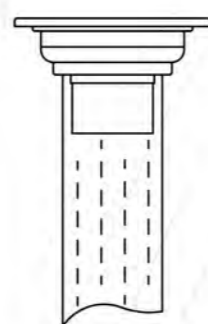

No Block

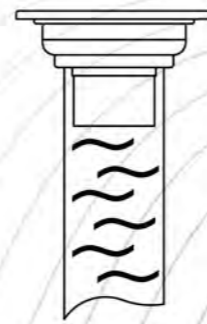

No Backflow

Since the point floor drains are widely used in residential purposes, we provide some examples of drain arrangements with tiles. The easiest way to align the point floor drain is to work with square tiles and/or mosaic tiles. But we don't limit your imagination – you are free to design unique and functional space on your own. Thanks to a large variety of Justime point floor drains you won't be limited to specific patterns and colors.

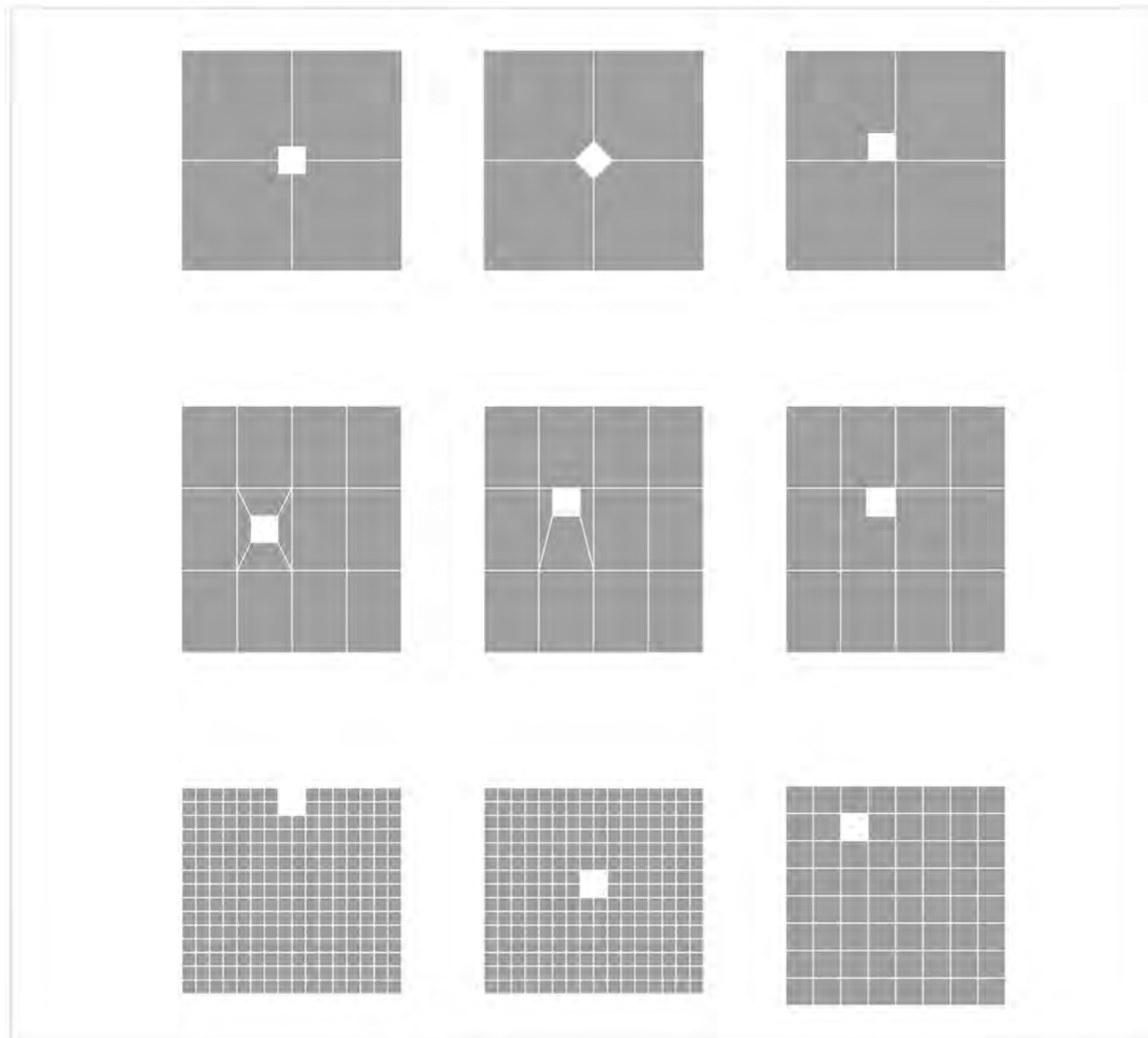

Justime linear floor drains create a one way pitch to drain the water. Therefore there are recommended to be used together with large tiles. You are able to create simple and clean shower floor arrangements together with our linear drains.

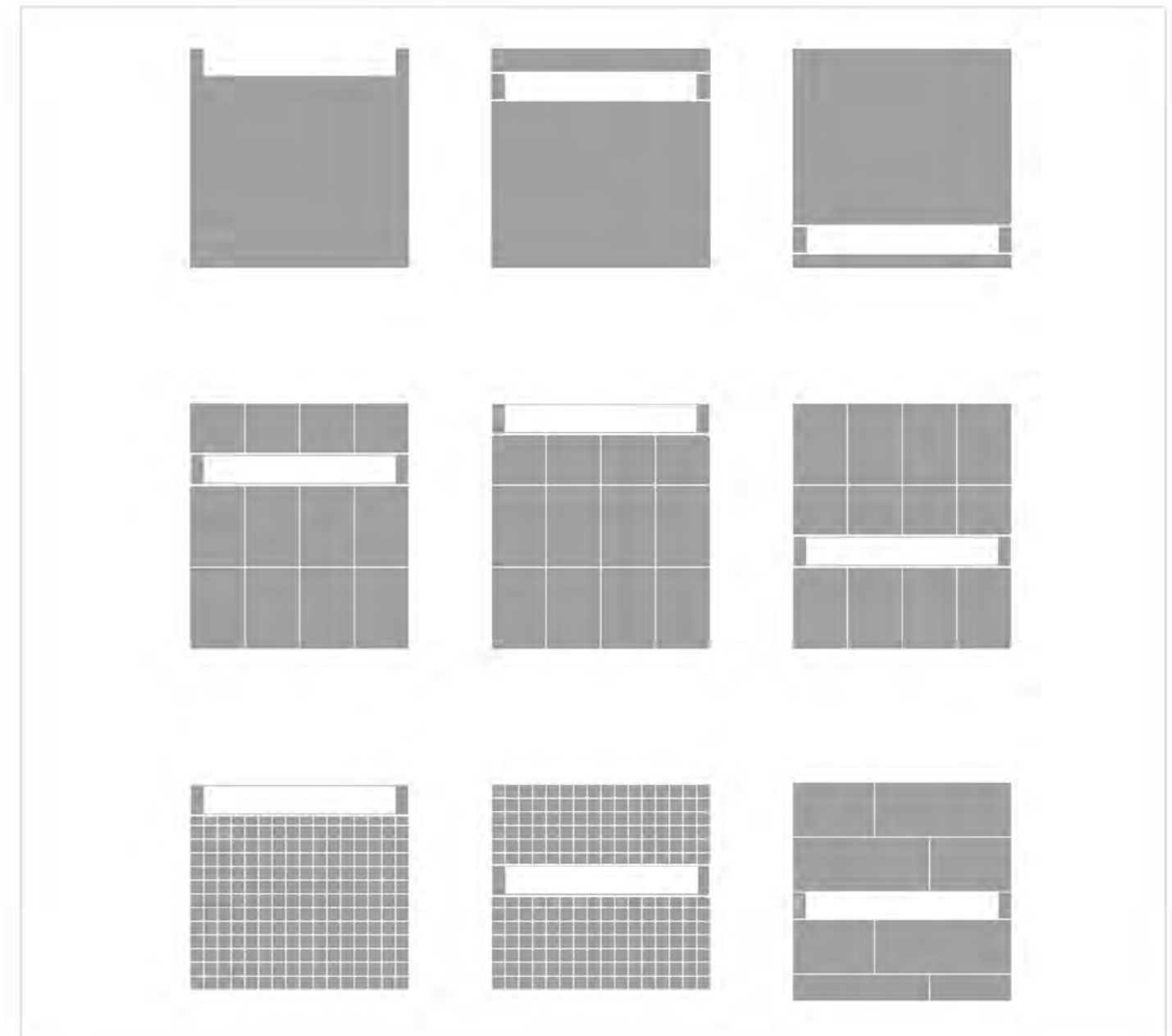

Justime premium linear solutions for hotel bathrooms guarantee maximum hygiene and safety. For builders, Justime floor drains offer the perfect way to plan and design a generous hotel bathroomshower. With an option to implement tiles into floor drain structure, hoteliers and architects may "hide" the visual aspects of the drain.

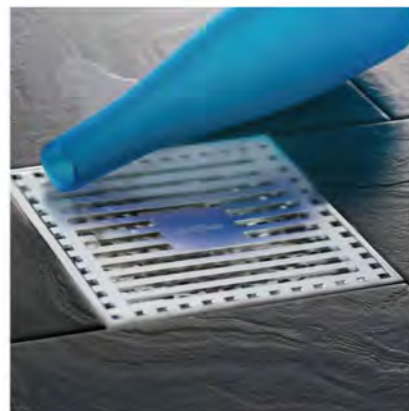

Thanks to a wide range of Justime floor drains, you can visualize the interior and find the perfect solution for your own design. Planning to have a unique look with interesting patterns, the point brass floor drain is your option. Thanks to the triangle shape of stainless steel drain, you are able to customize the shower area in the bathroom.

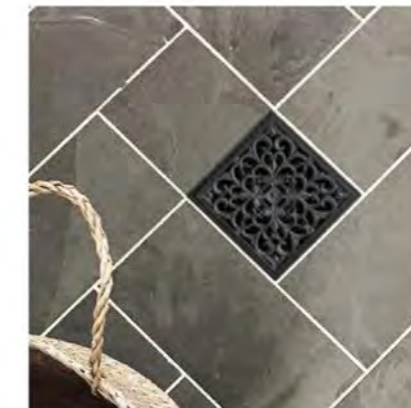

## Brass point floor drain



0303-64-79MA

## Chrome CP

A very classy shiny chrome finish is easy to match with other accessories and interior style in general.

## White CW

Light and clear colors are widely used in the modern interior designs. Therefore white fittings by Justime are able to complement the entire look of the space.

## Gold PK

A rich look of house accessories had been always attracted many eyes of your guests. With Justime PK gold finish you'll be able to highlight the most interesting parts of your interior.

## Matte Black MA

Black floor drain is a great choice to match your black shower system and Justime accessories in black colors. With recent growth in demand for black and yellow colors, the Justime fittings in both Gold and Black Matte finishes follow this popular trend.

## Antique brass AB

There are a lot of people who prefer rustic and classic traditional styles over other modern interior trends. With antique brass finish your product has its own charm and beauty that reflects in your house space.

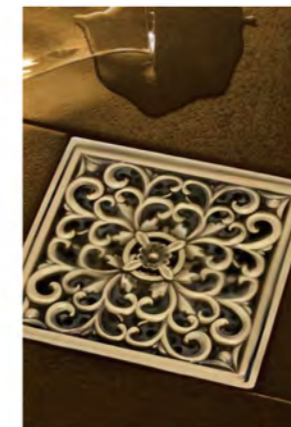

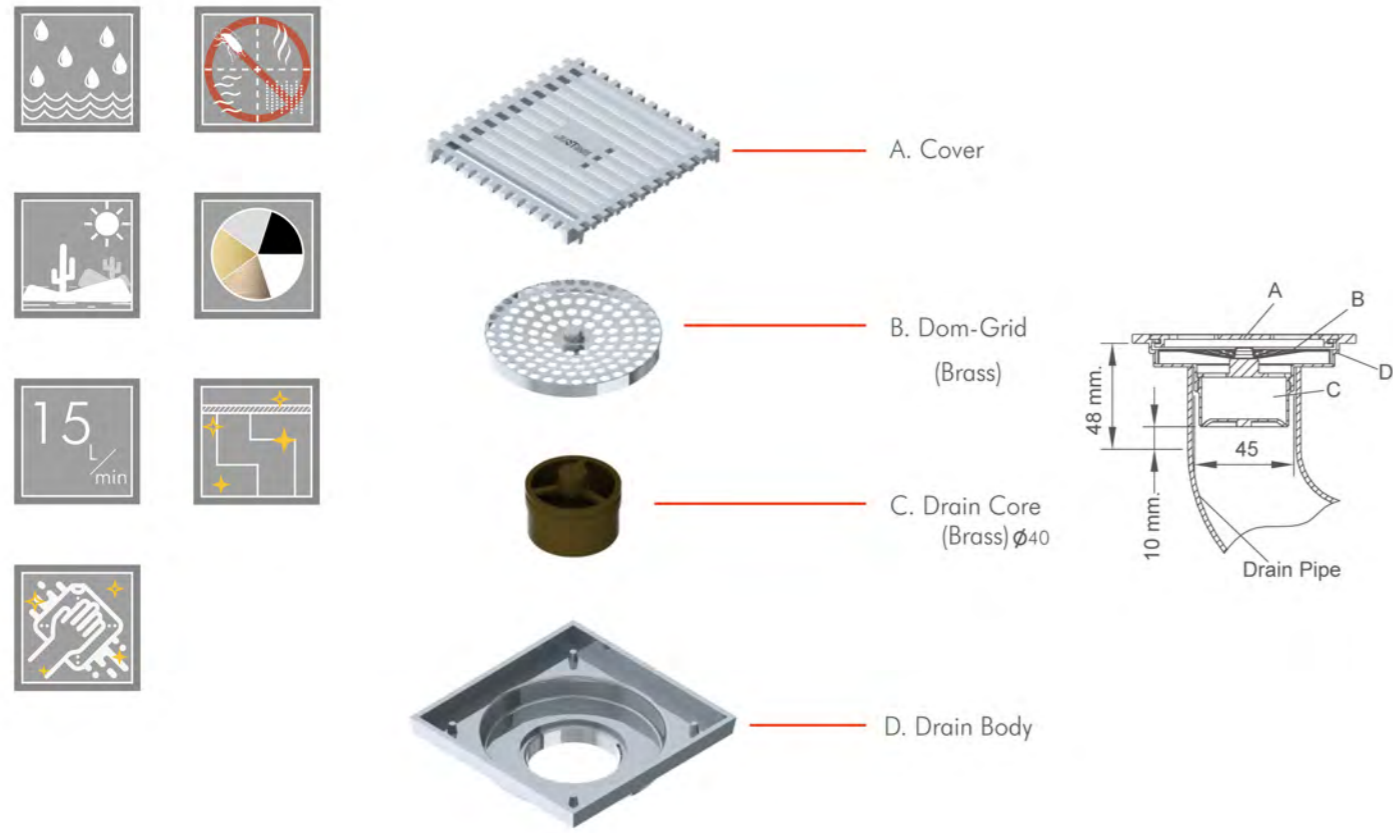

### A. Cover:

For point brass floor drains we provide different styles of covers – with oval lines, with straight lines and even with flower pattern. Additionally all of the Justime brass floor drains come in five different colors for your choice: Matte Black, White, Chrome, Gold and Antique Brass. This way you will have a freedom to choose the right style for your own unique interior.

### B. Dom-Grid

A special dom-grid included in the Justime floor drain design. This part of the product works as a “filter” to catch hair, small trash and other unwanted particles. It helps to keep your drain system clean and prevent your pipes to be clogged up.

### C. Drain Core

The “heart” of the floor drain. Made of high quality brass, it ensures the durable and long-lasting lifespan. Functional design prevents bad smells get into the room, protect your home from insects and it has no backflow.

### D. Drain Body

The drain body is also made of high grade quality brass. Connection to the waste pipe is done with diameter of 45 mm.





0303-62-79CP

Floor Drain  
Brass

Size 100\*100 mm  
Height 43 mm  
Seal Type Self Seal Brass  
Flow Rate  $\geq 15L/Min$   
Outlet OD 40 mm  
Drain Core 0303-A1-7900

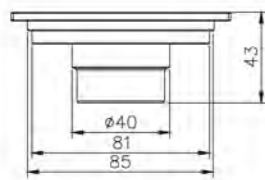
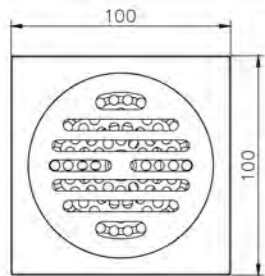

0303-62-79CW

Floor Drain  
Brass

Size 100\*100 mm  
Height 43 mm  
Seal Type Self Seal Brass  
Flow Rate  $\geq 15L/Min$   
Outlet OD 40 mm  
Drain Core 0303-A1-7900

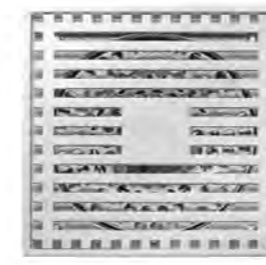
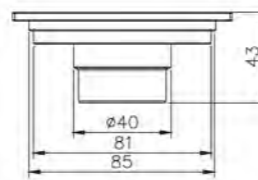
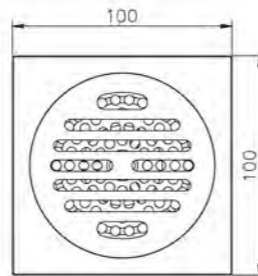

0303-64-79CP

Floor Drain  
Brass

Size 100\*100 mm  
Height 51 mm  
Seal Type Self Seal Brass  
Flow Rate  $\geq 15L/Min$   
Outlet OD 40 mm  
Drain Core 0303-A1-7900

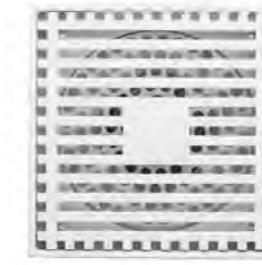
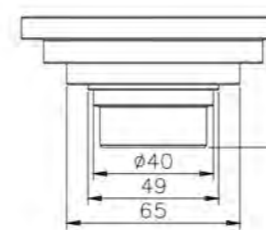
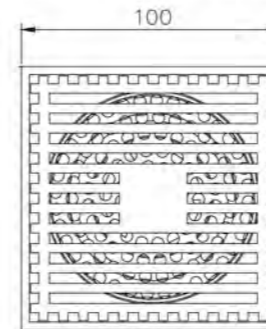

0303-64-79CW

Floor Drain  
Brass

Size 100\*100 mm  
Height 51 mm  
Seal Type Self Seal Brass  
Flow Rate  $\geq 15L/Min$   
Outlet OD 40 mm  
Drain Core 0303-A1-7900

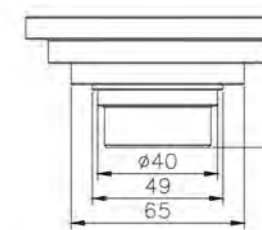

0303-62-79PK

Floor Drain  
Brass

Size 100\*100 mm  
Height 43 mm  
Seal Type Self Seal Brass  
Flow Rate  $\geq 15L/Min$   
Outlet OD 40 mm  
Drain Core 0303-A1-7900

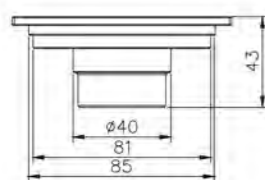
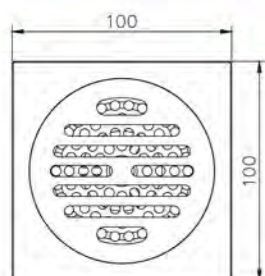

0303-62-79MA

Floor Drain  
Brass

Size 100\*100 mm  
Height 43 mm  
Seal Type Self Seal Brass  
Flow Rate  $\geq 15L/Min$   
Outlet OD 40 mm  
Drain Core 0303-A1-7900

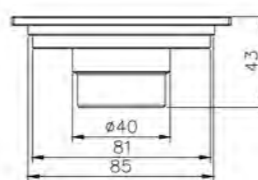
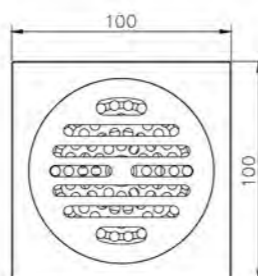

0303-64-79PK

Floor Drain  
Brass

Size 100\*100 mm  
Height 51 mm  
Seal Type Self Seal Brass  
Flow Rate  $\geq 15L/Min$   
Outlet OD 40 mm  
Drain Core 0303-A1-7900

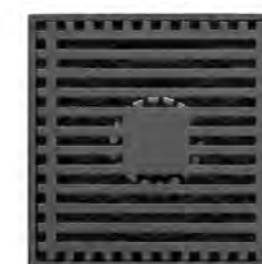
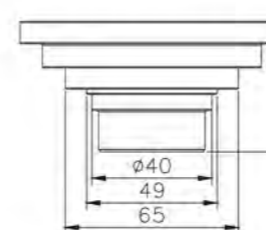
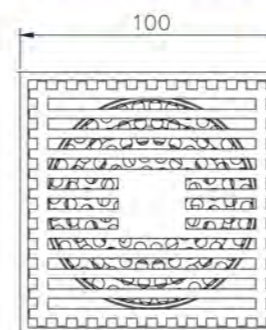

0303-64-79MA

Floor Drain  
Brass

Size 100\*100 mm  
Height 51 mm  
Seal Type Self Seal Brass  
Flow Rate  $\geq 15L/Min$   
Outlet OD 40 mm  
Drain Core 0303-A1-7900

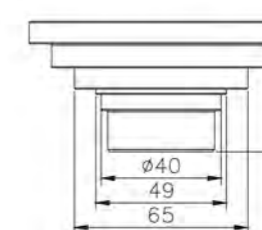
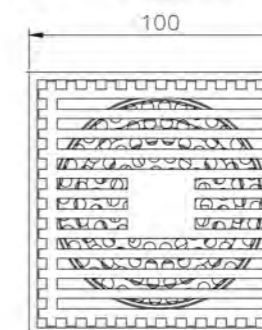





**0303-71-79CP**  
Floor Drain  
Brass  
Size 100\*100 mm  
Height 61 mm  
Seal Type Self Seal Brass  
Flow Rate ≥15L/Min  
Outlet OD 40 mm  
Drain Core 0303-A1-7900

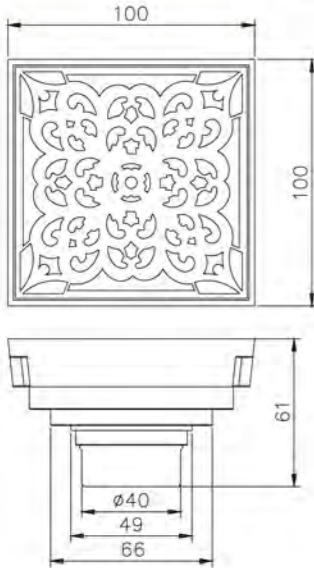

**0303-71-79CW**  
Floor Drain  
Brass  
Size 100\*100 mm  
Height 61 mm  
Seal Type Self Seal Brass  
Flow Rate ≥15L/Min  
Outlet OD 40 mm  
Drain Core 0303-A1-7900

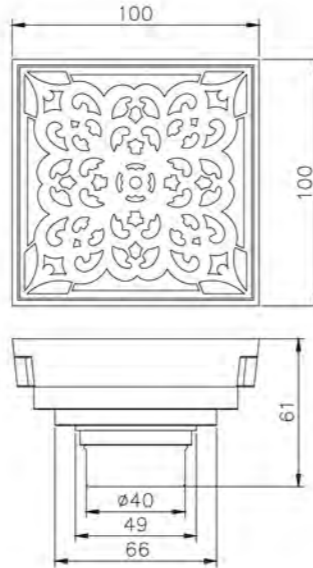

**0303-61-79CP**  
Floor Drain  
Brass  
Size 100\*100 mm  
Height 43 mm  
Seal Type Self Seal Brass  
Flow Rate ≥15L/Min  
Outlet OD 40 mm  
Drain Core 0303-A1-7900

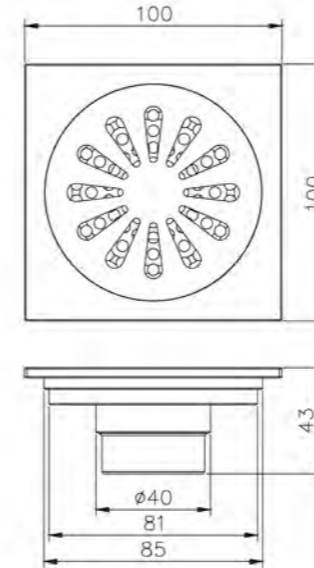

**0303-61-79CW**  
Floor Drain  
Brass  
Size 100\*100 mm  
Height 43 mm  
Seal Type Self Seal Brass  
Flow Rate ≥15L/Min  
Outlet OD 40 mm  
Drain Core 0303-A1-7900

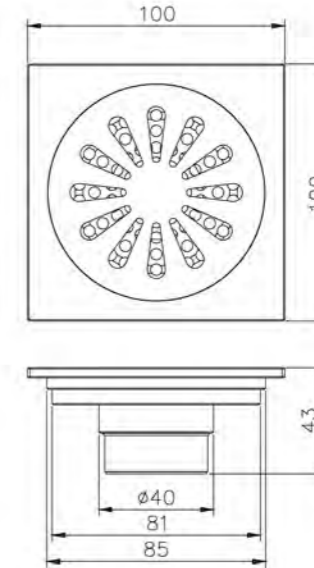

**0303-71-79AB**  
Floor Drain  
Brass  
Size 100\*100 mm  
Height 61 mm  
Seal Type Self Seal Brass  
Flow Rate ≥15L/Min  
Outlet OD 40 mm  
Drain Core 0303-A1-7900

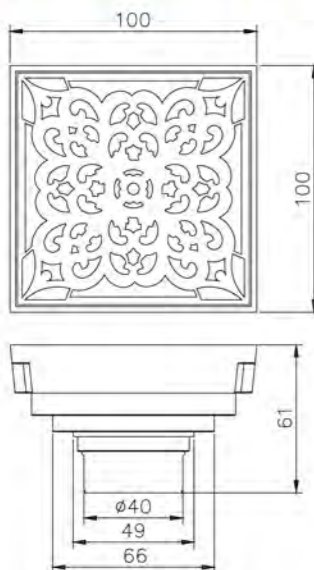

**0303-71-79MA**  
Floor Drain  
Brass  
Size 100\*100 mm  
Height 61 mm  
Seal Type Self Seal Brass  
Flow Rate ≥15L/Min  
Outlet OD 40 mm  
Drain Core 0303-A1-7900

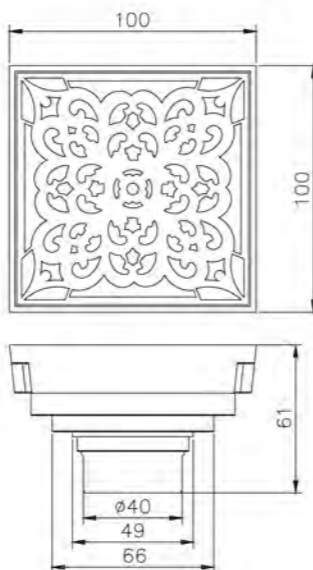

**0303-61-79PK**  
Floor Drain  
Brass  
Size 100\*100 mm  
Height 43 mm  
Seal Type Self Seal Brass  
Flow Rate ≥15L/Min  
Outlet OD 40 mm  
Drain Core 0303-A1-7900

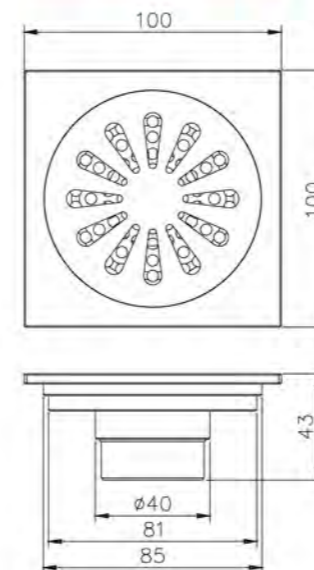

**0303-61-79MA**  
Floor Drain  
Brass  
Size 100\*100 mm  
Height 43 mm  
Seal Type Self Seal Brass  
Flow Rate ≥15L/Min  
Outlet OD 40 mm  
Drain Core 0303-A1-7900

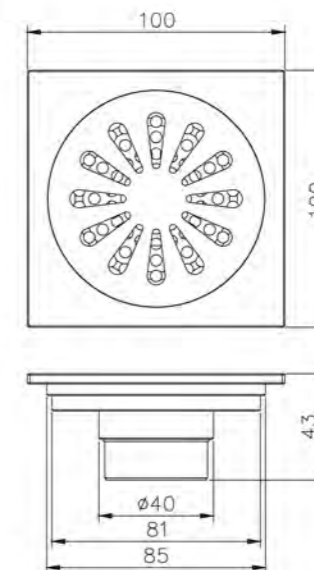

## Stainless steel floor drain with tile insertion



0306-10-7951

Stainless steel floor drain with a tile insertion function is your top choice if you'd like to visually hide the actual drain. In places like kitchen, guest bathroom and toilet it's vital to keep interior clean and stylish. Tile insertion option can help you to hide unwanted metal parts of the drain.

Available in various shapes, the Justime tile floor drain provides you with more freedom to create interesting and quite unique spaces.



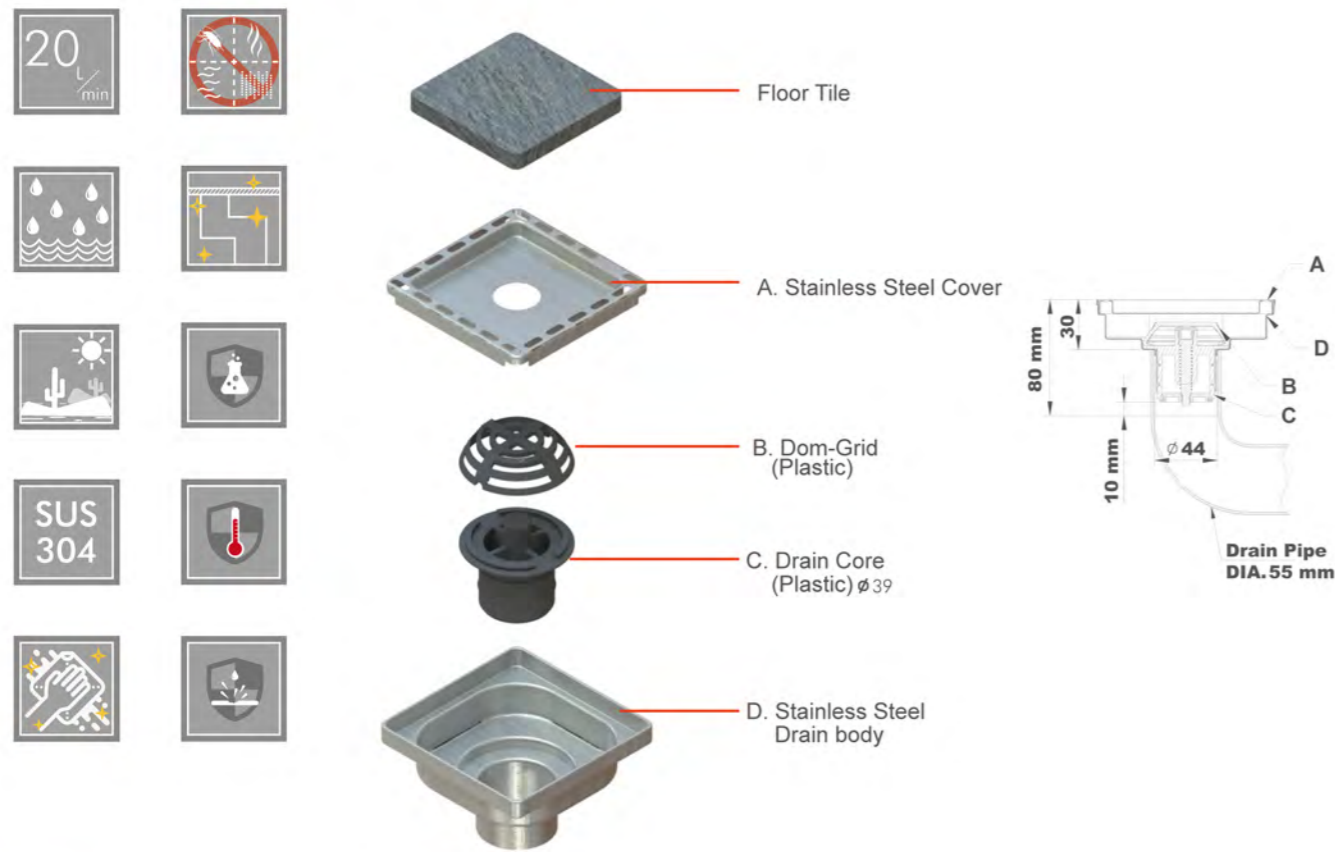

### A. Cover:

A special cover design is made to fit tiles inside. This will let you hide the floor drain from the eyesight and level perfectly the floor. Justime provides different shapes and sizes for stainless steel tile floor drains. Stainless steel material is also known for its good hygiene properties.

### B. Dom-Grid

In order to keep your drain clean and functional, dom-grid is a necessary part in floor drain construction. It works as a "filter" to catch hair, small trash and other unwanted particles. It helps to keep your drain system clean and prevent your pipes to be clogged up.

### C. Drain Core

This part of the product is responsible for keeping your bathroom bugs free & smell free. By the time water is drained out, the drain core closes its valve/latch. It also protects you from unwanted dangerous gases from the pipe systems.

### D. Drain Body

Made of stainless steel, the drain body has following characteristics – acid resistant, erosion resistant and heat resistant. Connection to the waste pipe is done with diameter of 44 mm.

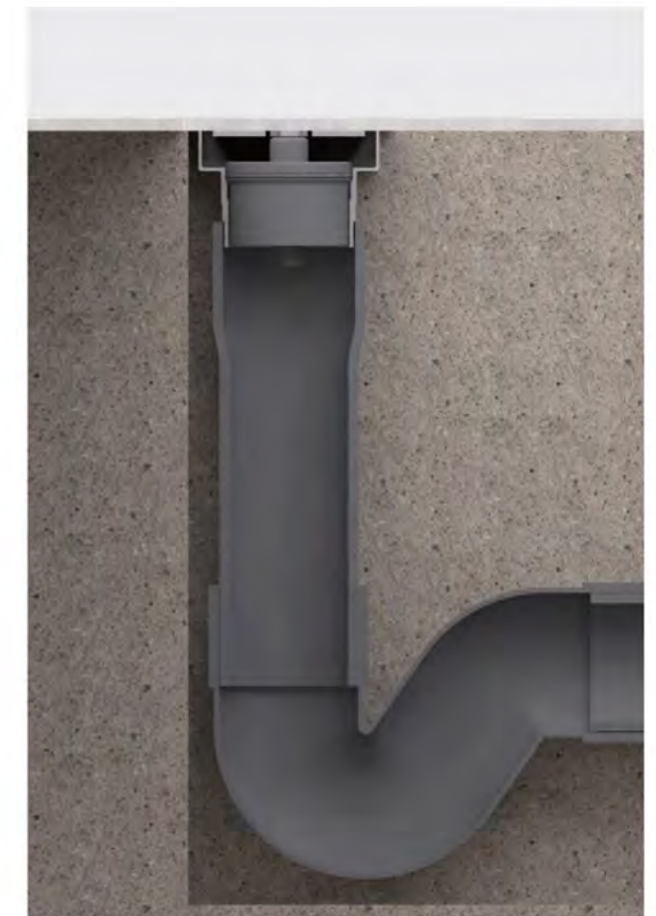
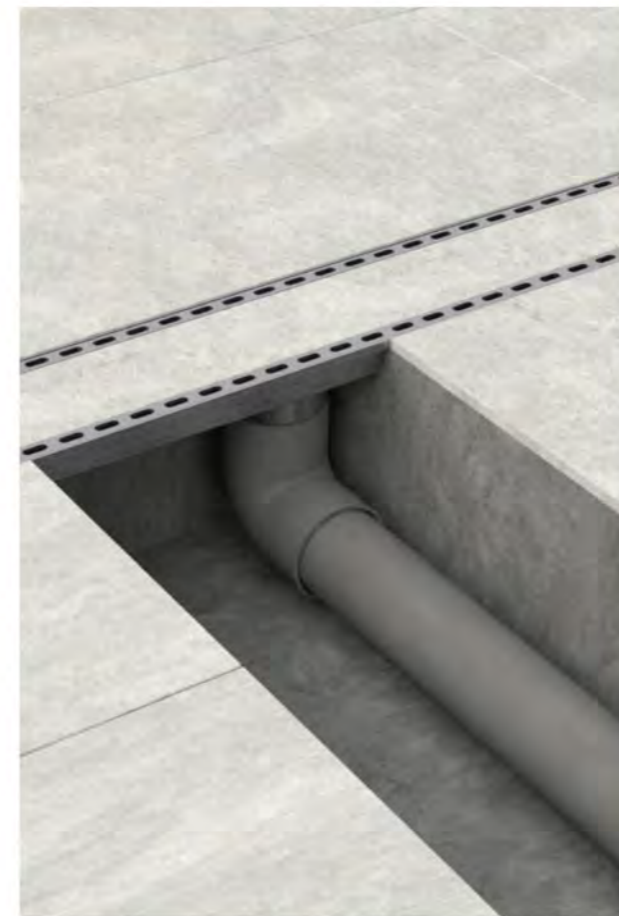



**0306-10-79S1**  
Floor Drain  
USU 304

Size 125\*125 mm  
Height 65 mm  
Seal Type Self Seal ABS  
Flow Rate  $\geq 18$  L/Min  
Outlet OD 42.0 mm  
Drain Core 0305-A1-7900

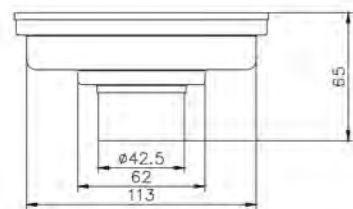
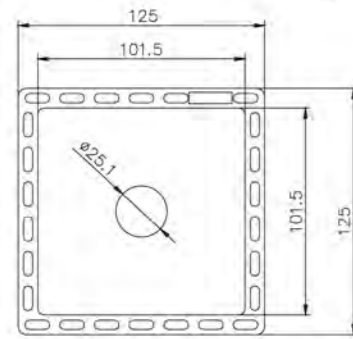

**0306-12-79S1**  
Floor Drain  
USU 304

Size 102\*102 mm  
Height 65 mm  
Seal Type Self Seal ABS  
Flow Rate  $\geq 18$  L/Min  
Outlet OD 42.0 mm  
Drain Core 0305-A1-7900

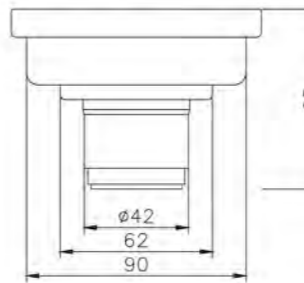
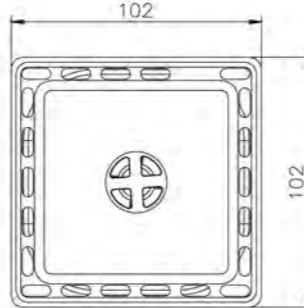

**0306-54-79S1**  
Floor Drain  
SUS 304

Size 527\*127 mm  
Height 65 mm  
Seal Type Self Seal ABS  
Flow Rate  $\geq 22$  L/Min  
Outlet OD 48.0 mm  
Drain Core 0306-A2-7900

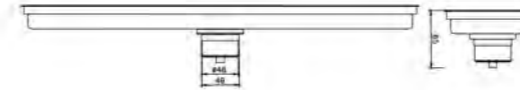
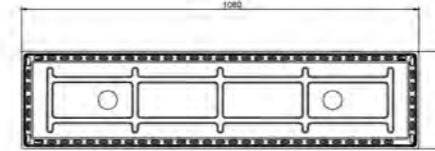

**0306-29-79S1**  
Floor Drain  
SUS 304

Size 200\*200 mm  
Height 57 mm  
Seal Type Self Seal ABS  
Flow Rate  $\geq 18$  L/Min  
Outlet OD 42.0 mm  
Drain Core 0305-A2-7900

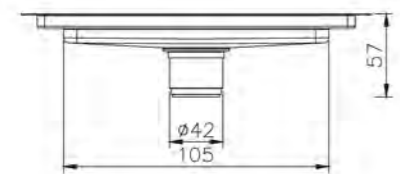
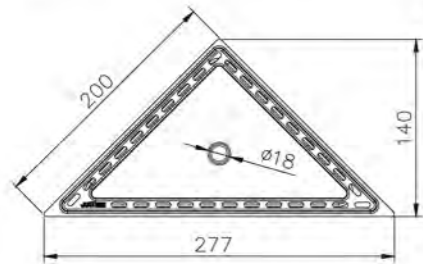

**0306-60-79S1**  
Floor Drain  
SUS 304

Size 600\*80 mm  
Height 60 mm  
Seal Type Self Seal ABS  
Flow Rate  $\geq 25$  L/Min  
Outlet OD 48 mm  
Drain CoreD 0306-A3-7900

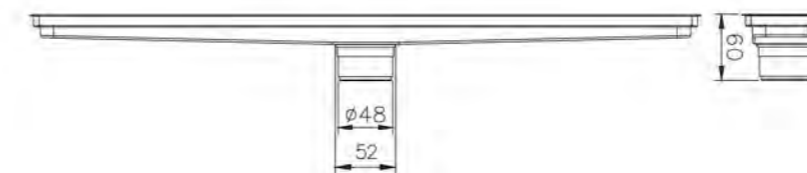
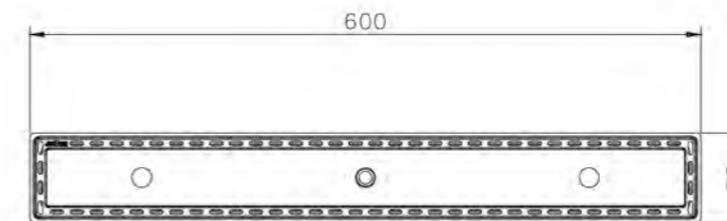

## Stainless steel point floor drain :



Stainless steel (s/steel) provides an attractive, clean finish with low maintenance cost. This material is the most common form of iron-based metals used around the world, largely due to its excellent corrosion resistance and value. S/steel withstand corrosion from most oxidizing acids & alkaline solutions. It also maintains high strength at very high temperatures.

And because s/steel has the exceptional hygienic properties, Justime applies it in production of floor drains, additionally to other stainless steel products. Its hygiene advantages make it to be the first choice for commercial uses, hospitals, kitchens and food processing facilities.

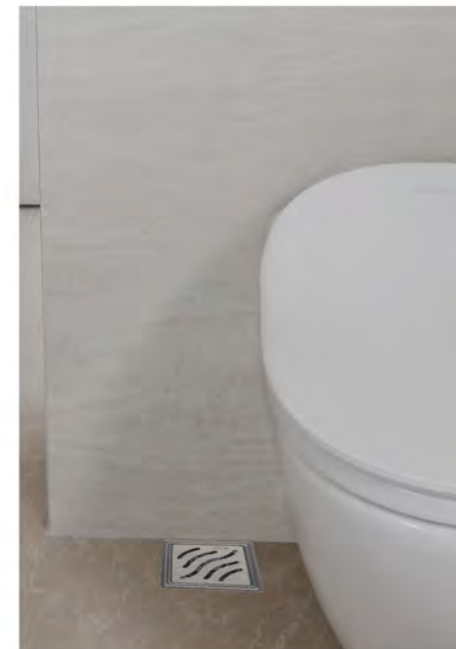

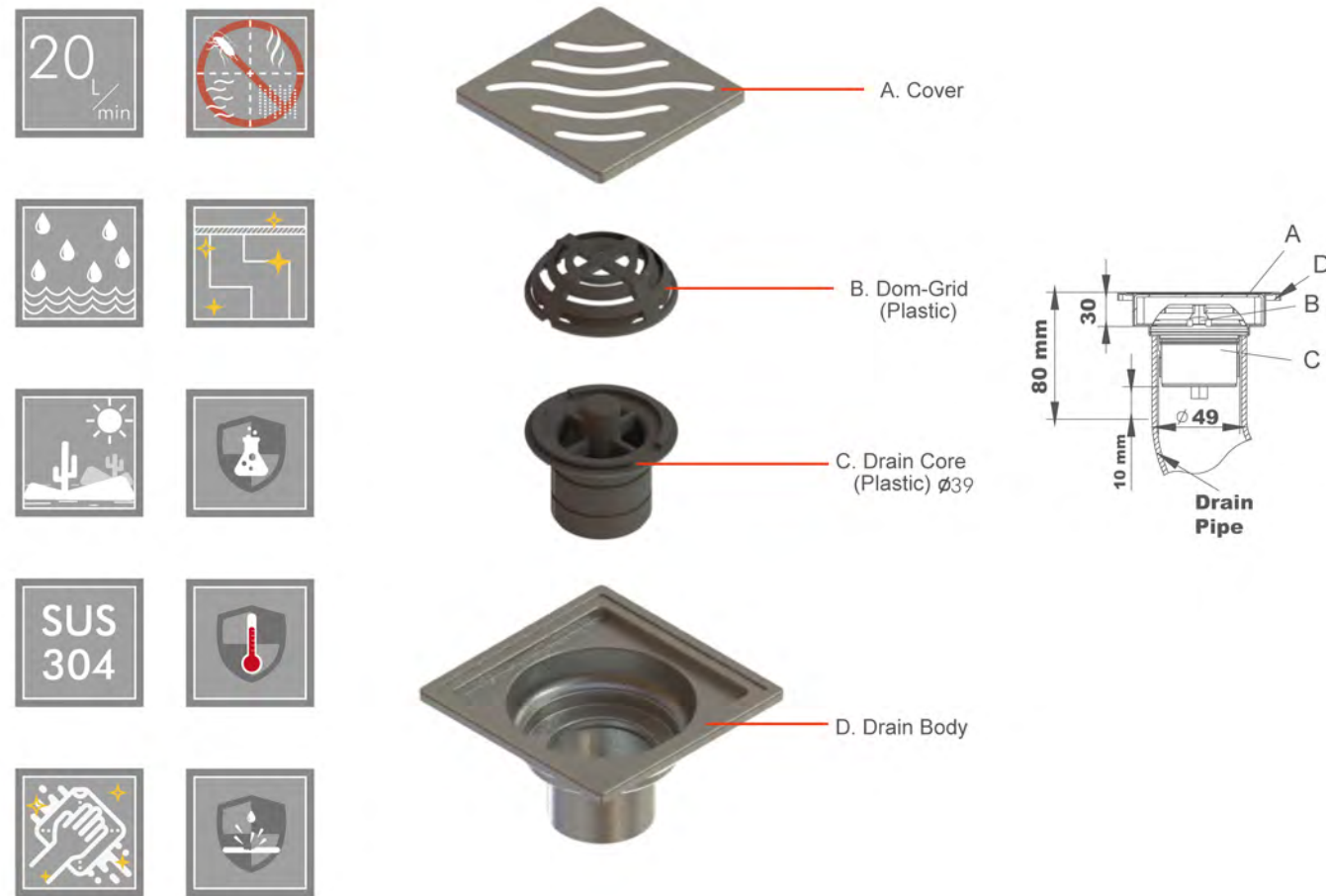

### A. Cover:

Justime provides different shapes and sizes for stainless steel tile floordrains. Stainless steel material is also known for its good hygiene properties.

### B. Dom-Grid

In order to keep your drain clean and functional, dom-grid is a necessary part in floor drain construction. It works as a “filter” to catch hair, small trash and other unwanted particles. It helps to keep your drain system clean and prevent your pipes to be clogged up.

### C. Drain Core

This part of the product is responsible for keeping your bathroom bugs free & smell free. By the time water is drained out, the drain core closes its valve/latch. It also protects you from unwanted dangerous gases from the pipe systems.

### D. Drain Body

Made of stainless steel, the drain body has following characteristics – acid resistant, erosion resistant and heat resistant. Connection to the waste pipe is done with diameter of 44 mm.





0305-21-79S1

Floor Drain  
SUS 304

Size 102\*102 mm  
Height 57 mm  
Seal Type Self Seal ABS  
Flow Rate ≥15L/Min  
Outlet OD 42 mm  
Drain Core 0305-A1-7900

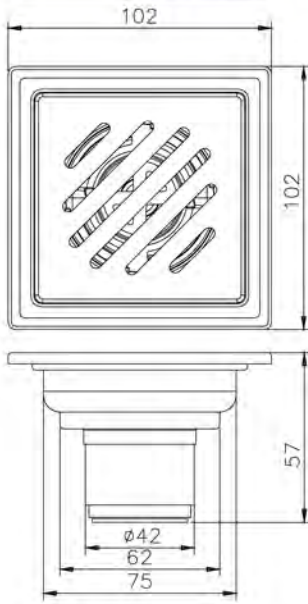

0305-19-79S1

Floor Drain  
SUS 304

Size 102\*102 mm  
Height 57 mm  
Seal Type Self Seal ABS  
Flow Rate ≥15L/Min  
Outlet OD 42 mm  
Drain Core 0305-A1-7900

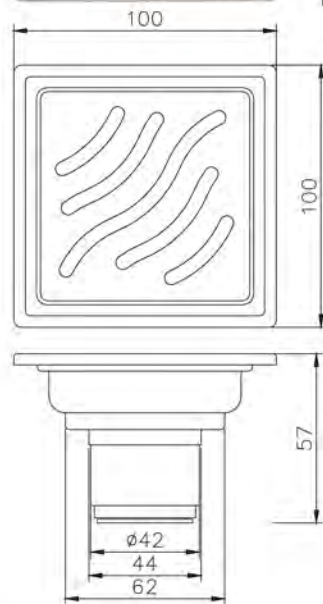

0305-03-79S1

Floor Drain  
SUS 304

Size 102\*102 mm  
Height 57 mm  
Seal Type Self Seal ABS  
Flow Rate ≥15L/Min  
Outlet OD 42 mm  
Drain Core 0305-A1-7900

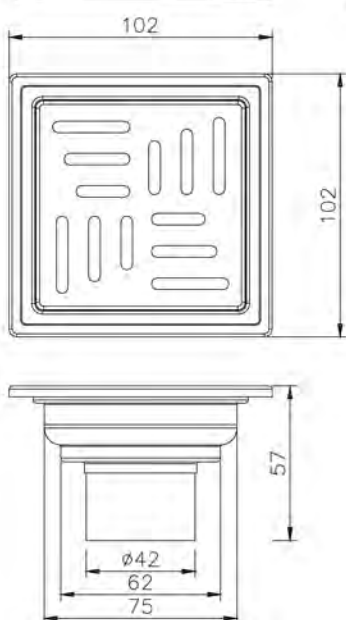

0305-04-79S1

Floor Drain  
SUS 304

Size 102\*102 mm  
Height 57 mm  
Seal Type Self Seal Brass  
Flow Rate ≥15L/Min  
Outlet OD 42 mm  
Drain Core 0305-A1-7900

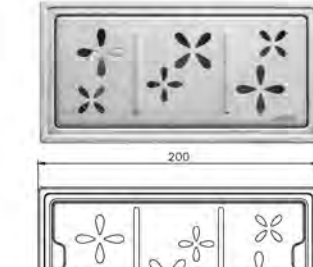
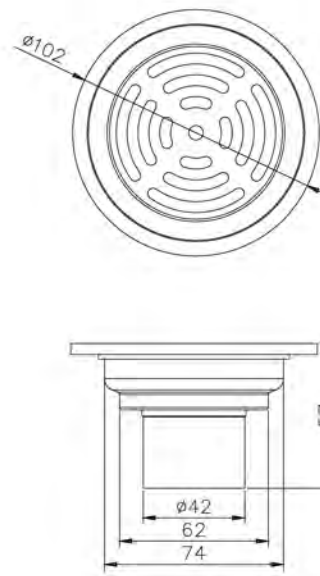

0305-01-79S1

Floor Drain  
SUS 304

Size 200\*100 mm  
Height 59 mm  
Seal Type Self Seal Brass  
Flow Rate ≥18L/Min  
Outlet OD 42mm  
Drain Core 0305-A1-7900

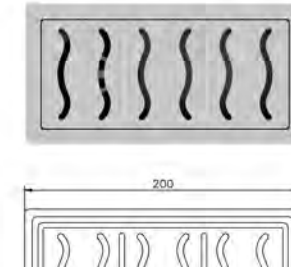

0305-18-79S1

Floor Drain  
SUS 304

Size 202\*102 mm  
Height 57 mm  
Seal Type Self Seal Brass  
Flow Rate ≥18L/Min  
Outlet OD 42 mm  
Drain Core 0305-A1-7900

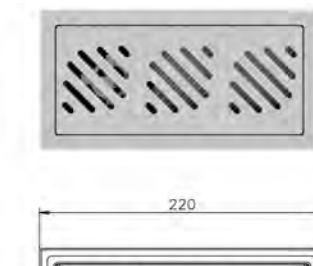
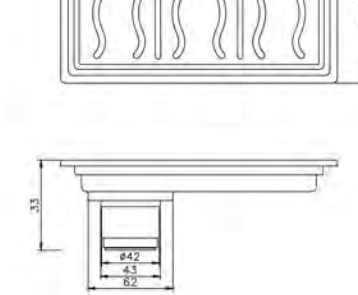

0305-20-79S1

Floor Drain  
SUS 304

Size 202\*102 mm  
Height 57 mm  
Seal Type Self Seal Brass  
Flow Rate ≥18L/Min  
Outlet OD 42mm  
Drain Core 0305-A1-7900

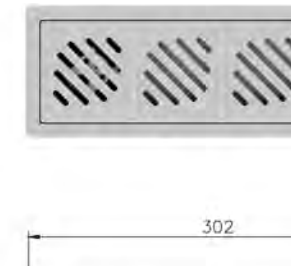
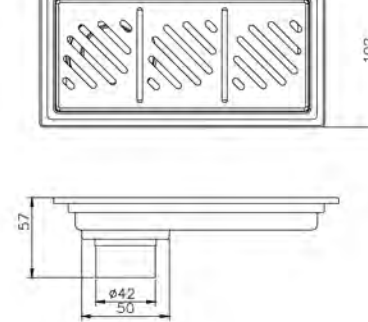

0305-22-79S1

Floor Drain  
SUS 304

Size 302\*102 mm  
Height 57 mm  
Seal Type Self Seal Brass  
Flow Rate ≥18L/Min  
Outlet OD 42 mm  
Drain Core 0305-A1-7900

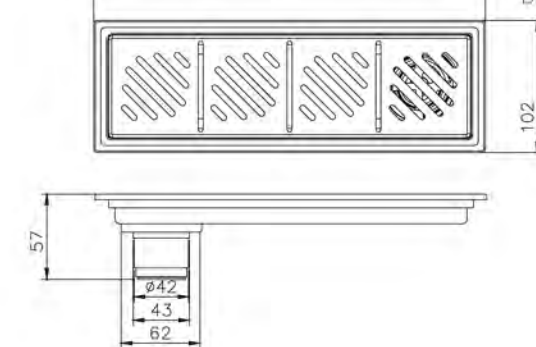

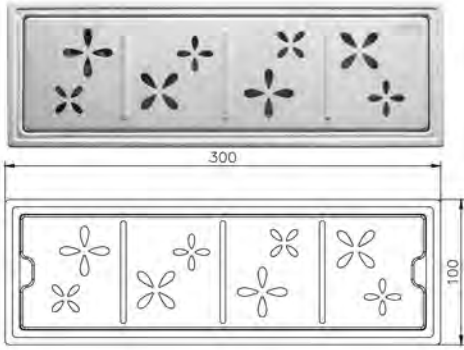

0305-07-79S1

Floor Drain  
SUS 304

Size 300\*100 mm  
Height 59 mm  
Seal Type Self Seal ABS  
Flow Rate  $\geq 15\text{L/Min}$   
Outlet OD 42 mm  
Drain Core 0305-A1-7900

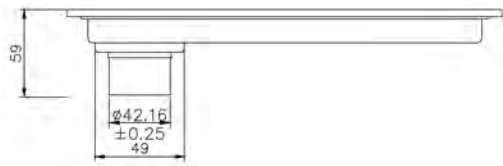

0305-11-79S1

Floor Drain  
SUS 304

Size 102\*102 mm  
Height 59 mm  
Seal Type Self Seal ABS  
Flow Rate  $\geq 15\text{L/Min}$   
Outlet OD 42 mm  
Drain Core 0305-A1-7900

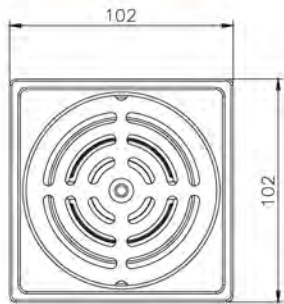





Similar to previous products shown, these floor drains are made of highly durable stainless steel. With clean look and nice finish, the Justime floor drains will enhance the overall living comfort.



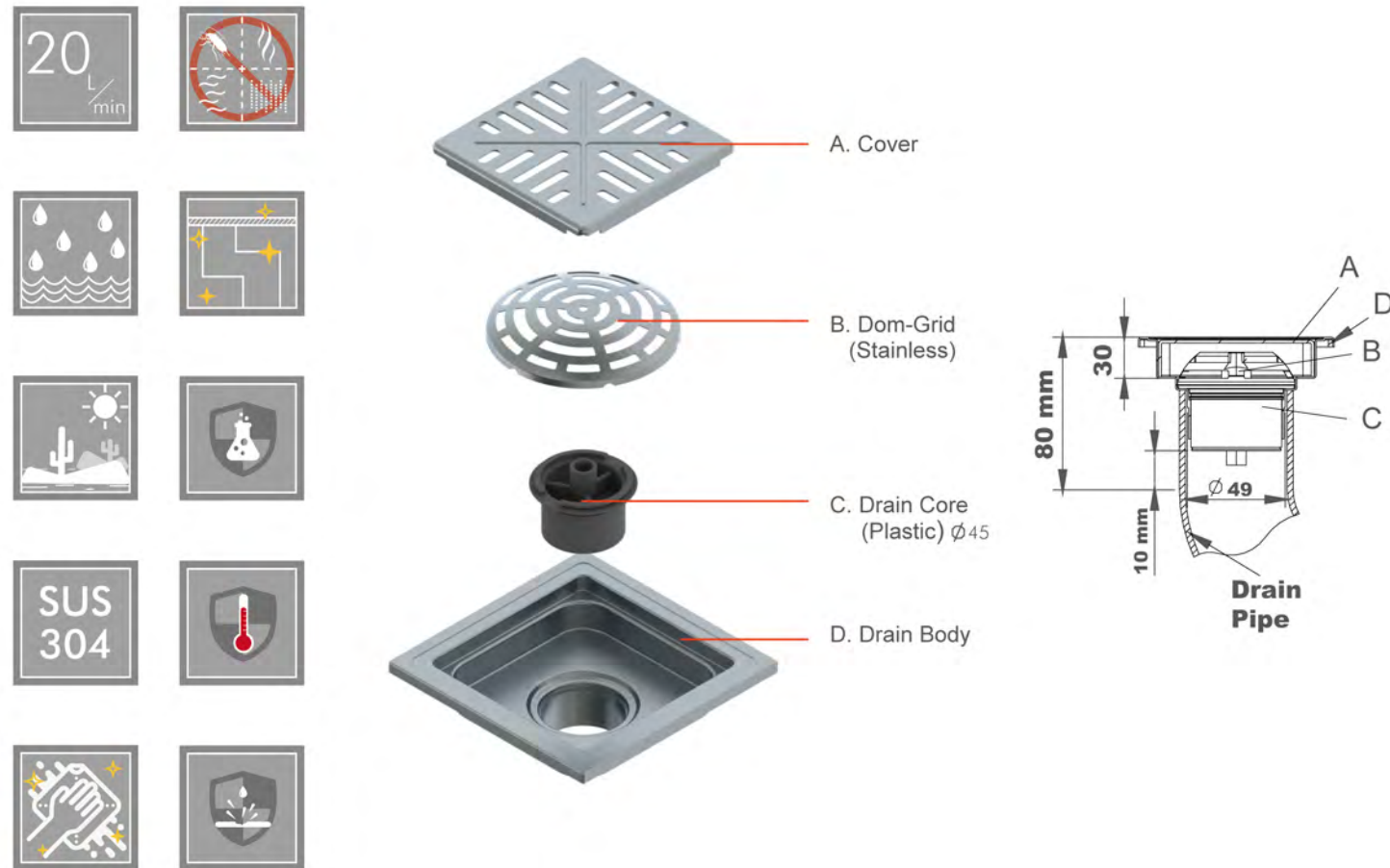

### A. Cover:

Justime provides different shapes and sizes for stainless steel tile floordrains. Stainless steel material is also known for its good hygiene properties.

### B. Dom-Grid

In order to keep your drain clean and functional, dom-grid is a necessary part in floor drain construction. It works as a "filter" to catch hair, small trash and other unwanted particles. It helps to keep your drain system clean and prevent your pipes to be clogged up.

### C. Drain Core

This part of the product is responsible for keeping your bathroom bugs free & smell free. By the time water is drained out, the drain core closes its valve/latch. It also protects you from unwanted dangerous gases from the pipe systems.

### D. Drain Body

Made of stainless steel, the drain body has following characteristics – acid resistant, erosion resistant and heat resistant. Connection to the waste pipe is done with diameter of 49 mm.





0305-05-79S1

Floor Drain  
SUS 304

Size	152*152 mm
Height	60 mm
Seal Type	Self Seal ABS
Flow Rate	≥ 22L/Min
Outlet OD	48 mm
Drain Core	0306-A2-7900

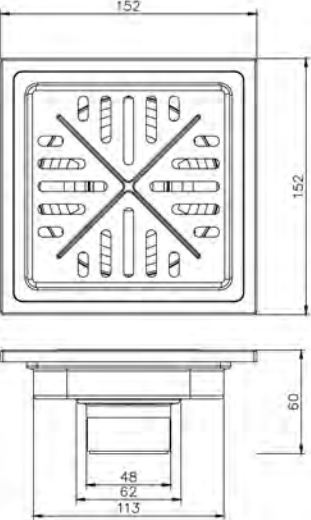



0305-28-79S1

Products from standard range sometimes are not the right choice for every application. Therefore, Justime also offers a wide variety of special solutions: linear floor drains with lengths up to 900mm and corner floor drains. Made of stainless steel, following floor drains are highly durable and withstand corrosion for longer period of time.

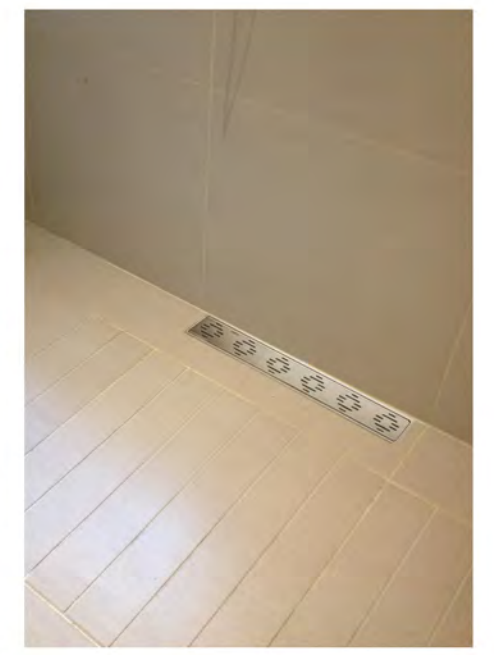
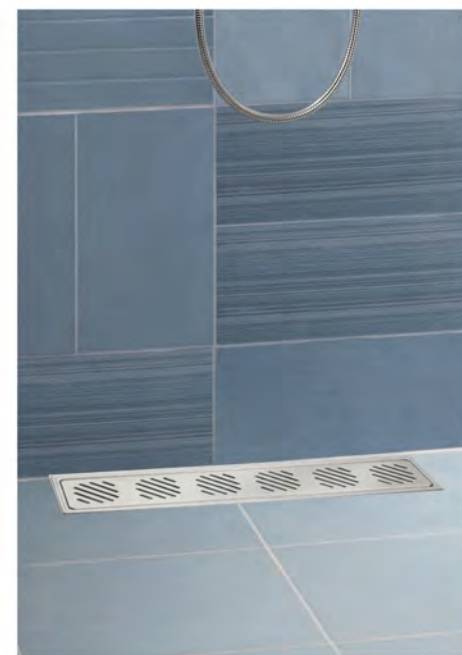

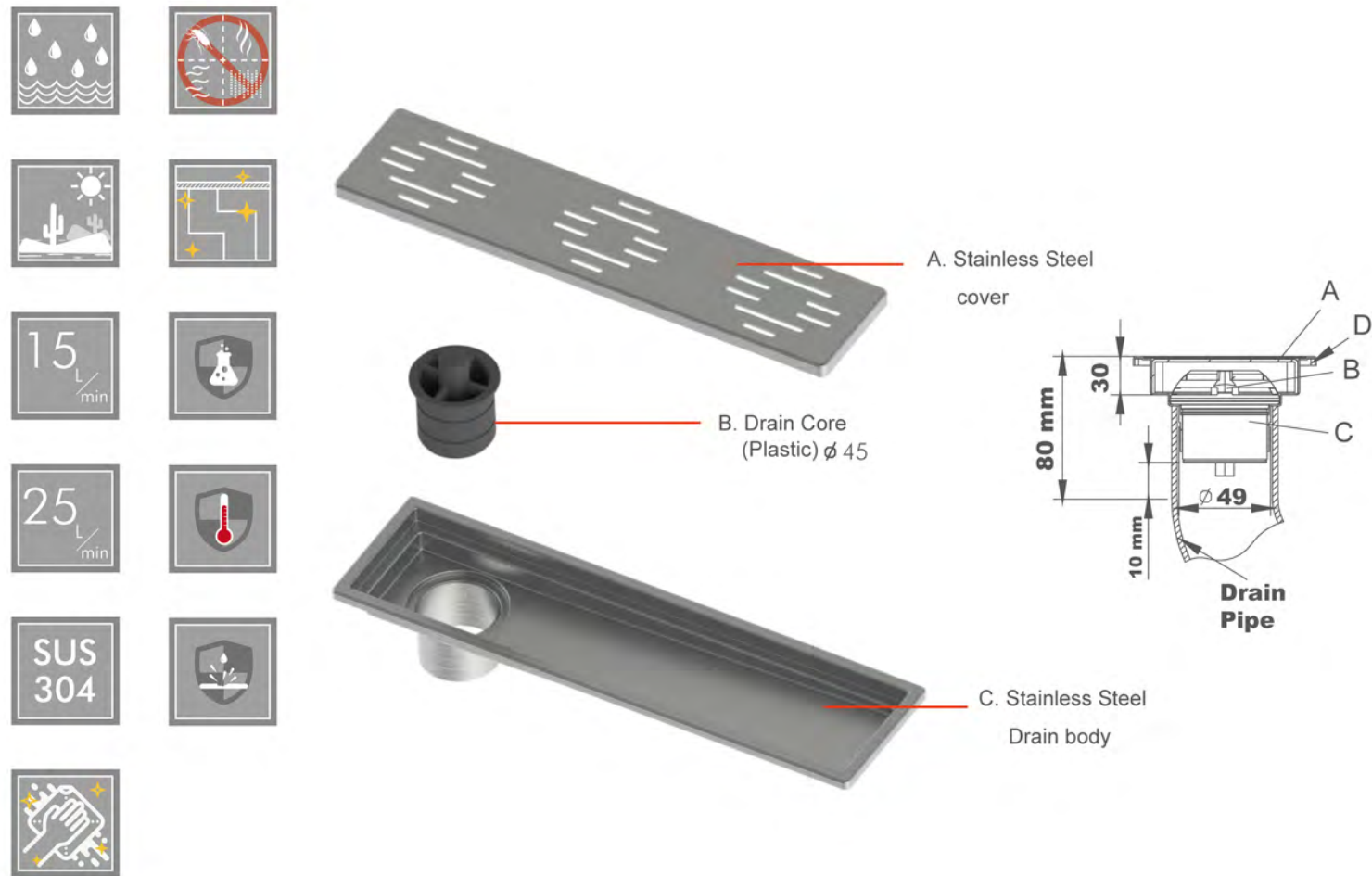

**A. Cover:**

Justime Linear floor drains come in different sizes and lengths. We provide simple and yet different patterns for stainless steel covers. This material is well known for its good hygiene properties.

**B. Drain Core**

This part of the product is responsible for keeping your bathroom bugs free & smell free. By the time water is drained out, the drain core closes its valve/latch. It also protects you from unwanted dangerous gases from the pipe systems.

**C. Drain Body**

Made of stainless steel, the drain body has following characteristics – acid resistant, erosion resistant and heat resistant. Connection to the waste pipe is done with diameter of 49 mm.



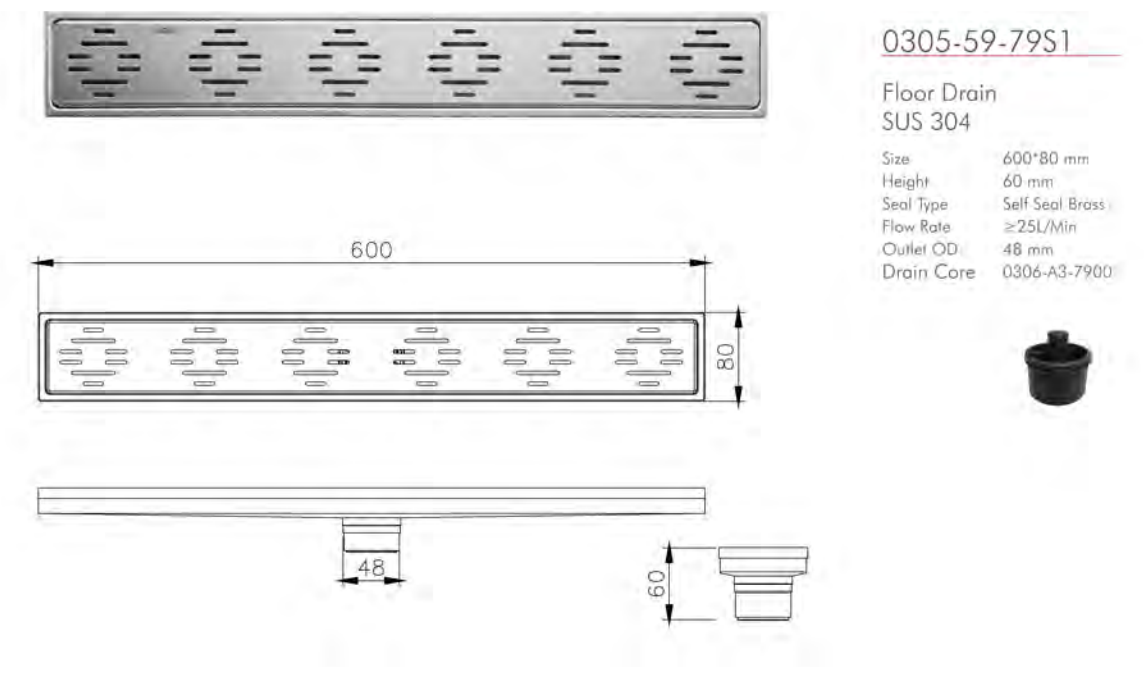
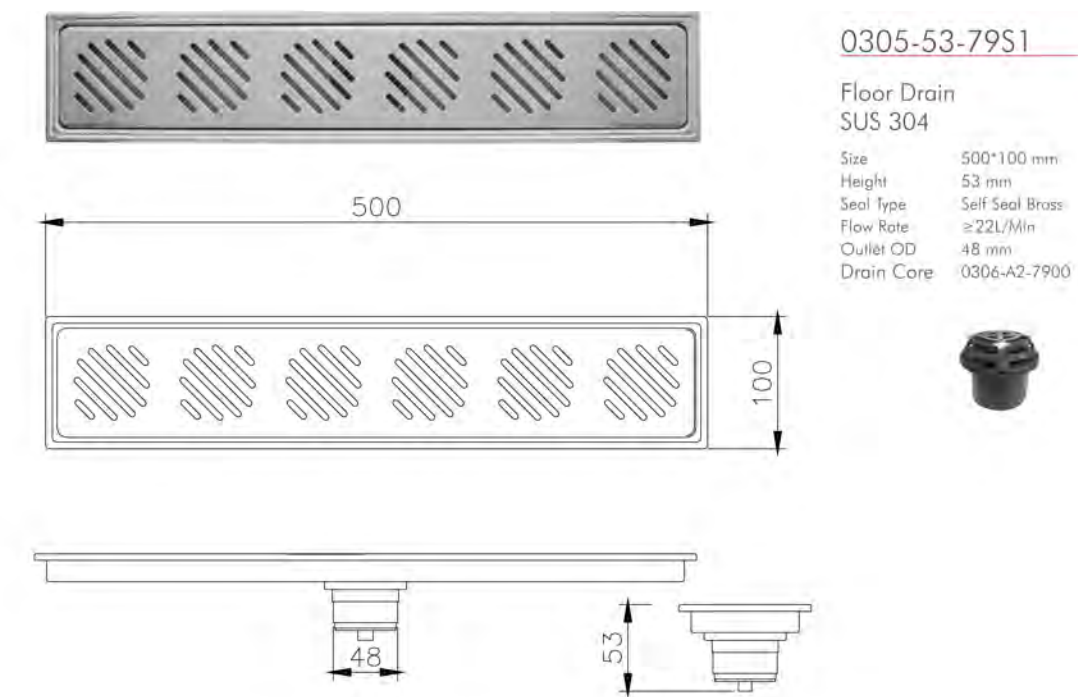
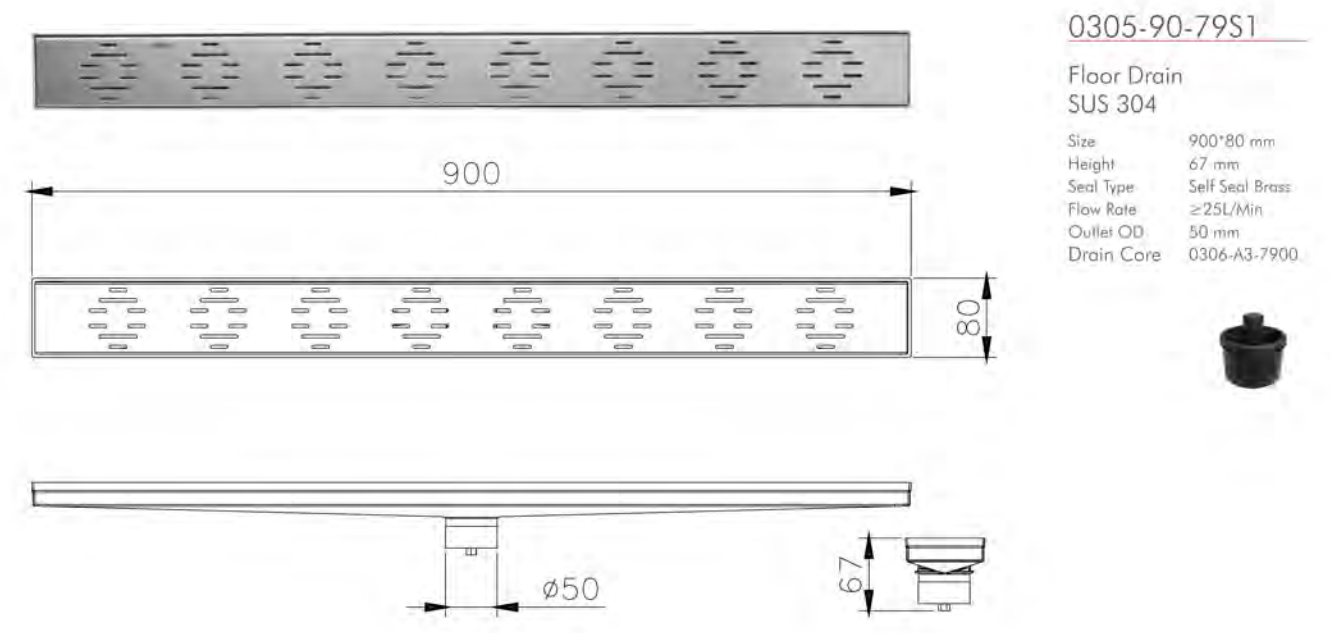
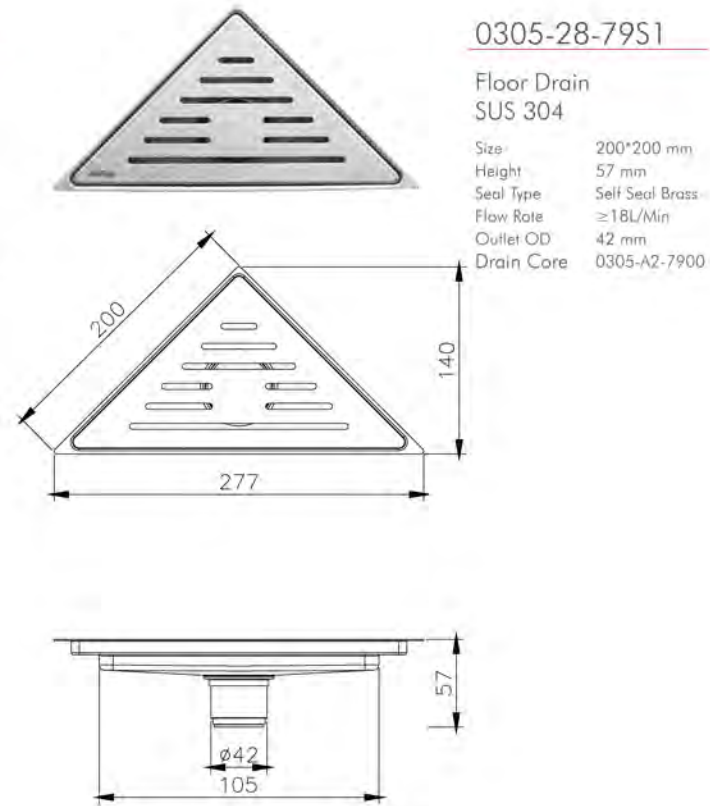
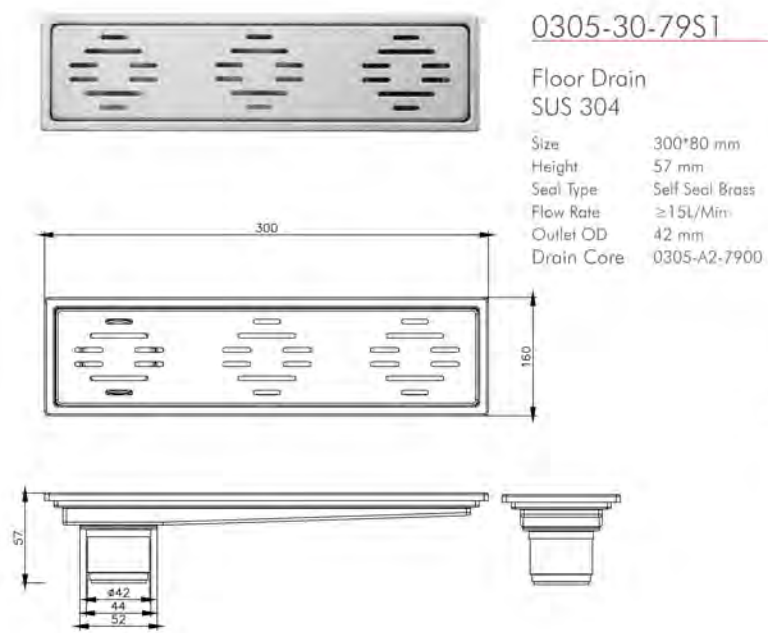



Outdoor facilities like swimming pools or theme water parks require drains with a high water drain capacity. Justime outdoor floor drains are capable of high water drainage at the rate 60 L/min. Therefore, this type of drains are preferable to be used in outdoor facilities with frequent water usage. Made of stainless steel, this floor drains ensures the high level of hygiene as well.



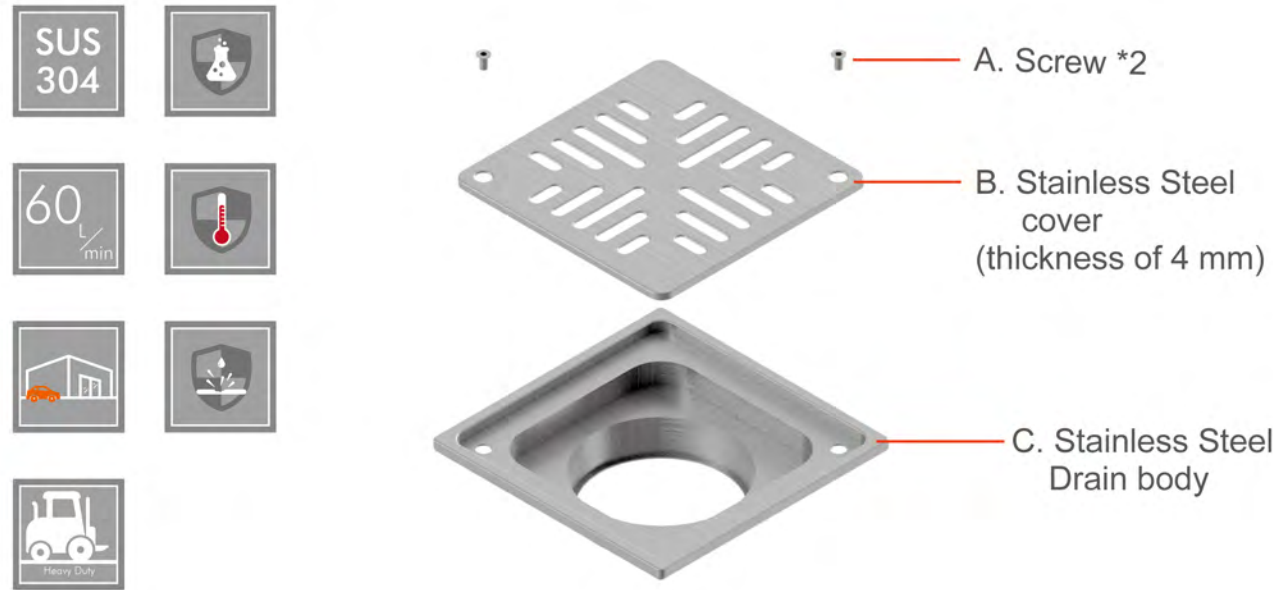

**A. Screw x 2**

Fixing screws are an important attribute to the floor drain since they are making products to be anti-vandal. Additionally, here at Justime we use only high quality materials to ensure product life span. Following screws are made of stainless steel SUS 304 which is acid and rust resistant.

**B. Cover**

Justime provides different shapes and sizes for stainless steel tile floor drains. Stainless steel material is also known for its good hygiene properties.

**C. Drain Body**

Made of stainless steel, the drain body has following characteristics – acid resistant, erosion resistant and heat resistant. Connection to the waste pipe is done with diameter of 90 mm. Due to the larger outlet diameter in 90 mm, the water flow rate is much higher (60 l/min) and fits perfectly the public/outdoor areas.

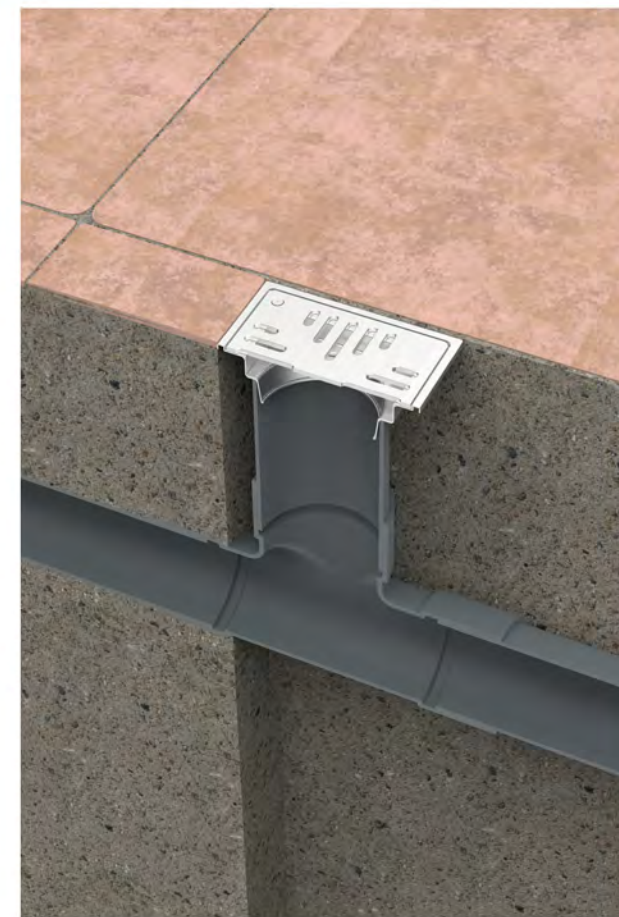





0307-27-79S1

Floor Drain  
SUS 304

Size 139\*139 mm  
Height 43 mm  
Seal Type  
Flow Rate ≥60L/Min  
Outlet OD 90.0 mm  
Drain Core

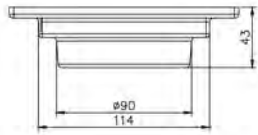
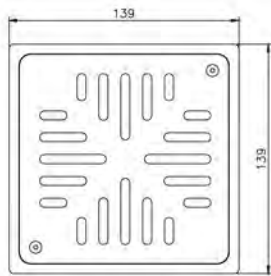

Drain core type

<p>0303-AB-68CP</p> 	<p>6305-A1-8000</p> 	<p>6305-A5-8000</p> 
<p>Applicable models</p> <p>0303-61-79CP 0303-62-79CP 0303-64-79CP 0303-71-79CP</p>	<p>Applicable models</p> <p>0305-01-79S1 0305-14-79S1 0305-03-79S1 0305-18-79S1 0306-10-79S1 0305-19-79S1 0305-07-79S1 0305-20-79S1 0305-04-79S1 0305-21-79S1 0305-11-79S1 0305-22-79S1 0306-12-79S1</p>	<p>Applicable models</p> <p>0306-54-79S1 0305-53-79S1</p>

Drain core type

<p>6305-A2-8000</p> 	<p>6305-A3-8000</p> 	<p>6305-A4-8000</p> 
<p>Applicable models</p> <p>0305-59-79S1 0306-60-79S1 0305-90-79S1</p>	<p>Applicable models</p> <p>0305-28-79S1 0305-30-79S1 0306-29-79S1</p>	<p>Applicable models</p> <p>0305-05-79S1</p>



Traditional water sealing is a simple and quite effective way of protecting your bath/kitchen space from bad smells and insects. It's highly recommended for spaces with frequent water usage (showers, toilets, etc.). Due to its simplicity in design and material used, the maintenance of it is pretty simple.



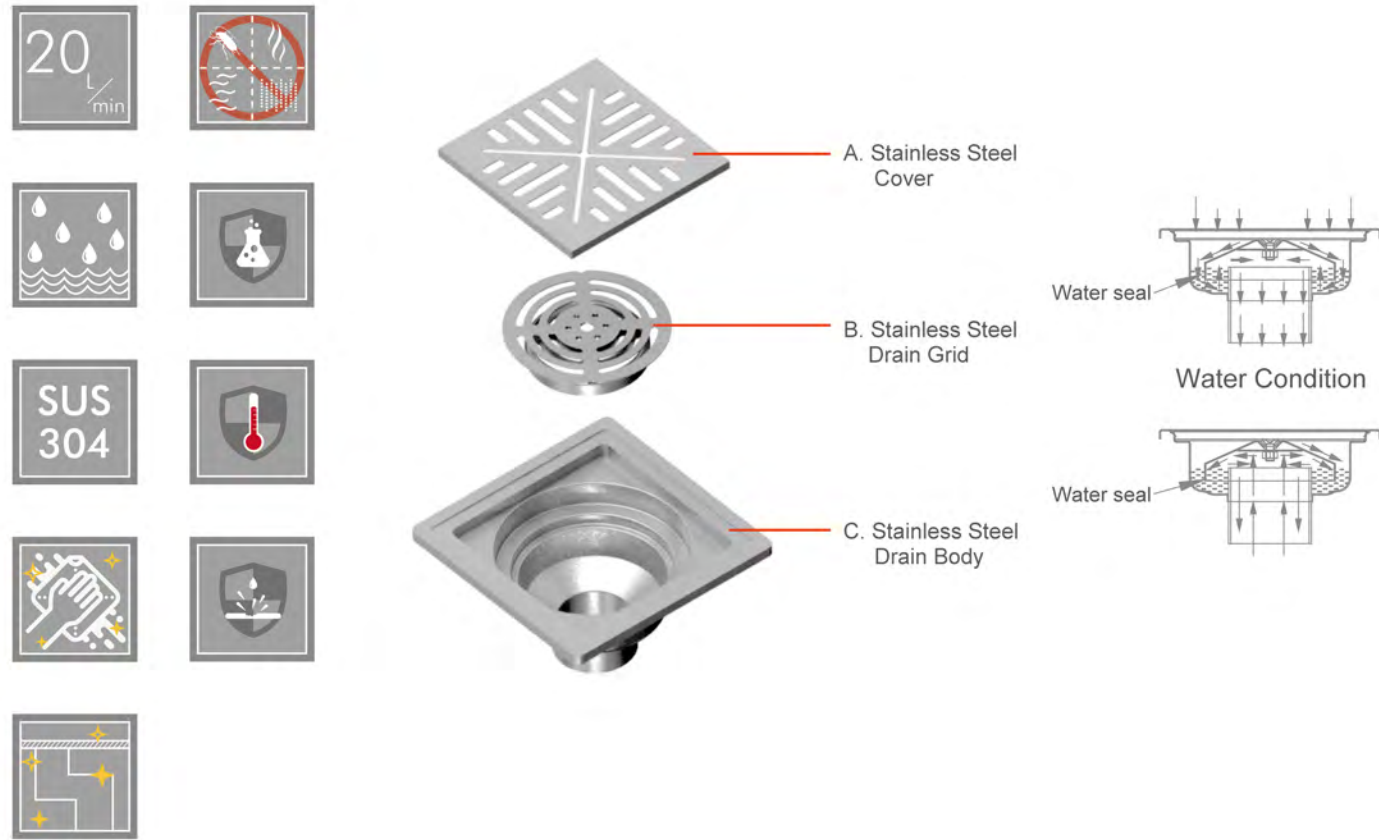

**A. Cover:**

Justime provides different shapes and sizes for stainless steel tile floor drains. Stainless steel material is also known for its good hygiene properties.

**B. Dom-Grid**

In order to keep your drain clean and functional, drain grid is a necessary part in floor drain construction. It works as a “filter” to catch hair, small trash and other unwanted particles. It helps to keep your drain system clean and prevent your pipes to be clogged up. It is extremely easy to clean your floor drain due to simplicity in Justime floor drain design.

**C. Drain Body**

Made of stainless steel, the drain body has following characteristics – acid resistant, erosion resistant and heat resistant. Connection to the waste pipe is done with diameter of 50.8 mm.

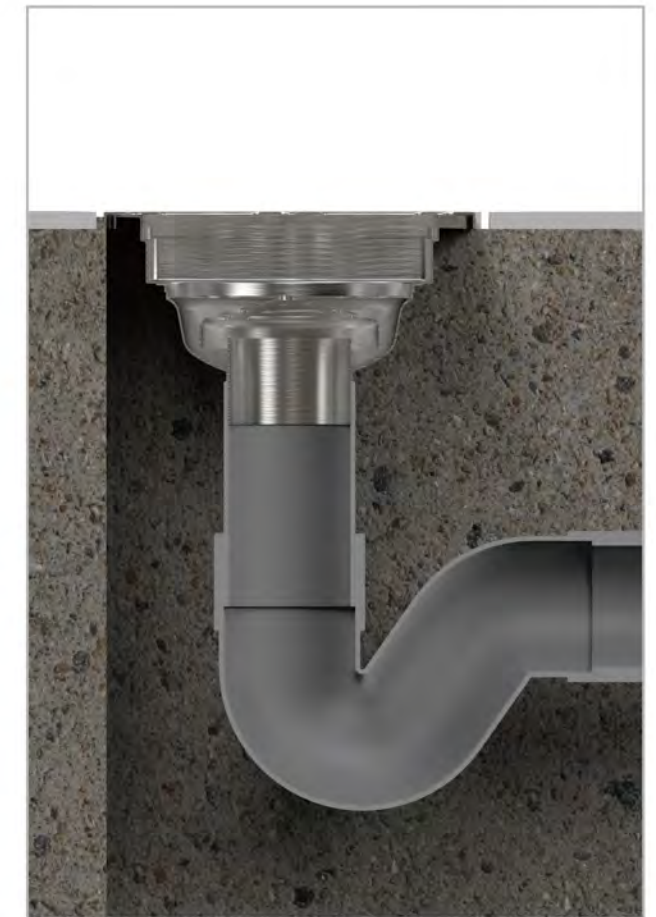



0305-02-79S1

Floor Drain  
SUS 304

Size 152.4\*152.4 mm  
Height 87.5 mm  
Seal Type Water Seal  
Flow Rate  $\geq 22L/Min$   
Outlet OD 50.8 mm  
Drain Core

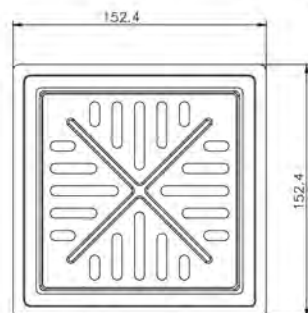

[www.vosoughishop.com](http://www.vosoughishop.com)

دفتر مرکزی : مشهد، بین قرنی ۳۱ و ۳۳

تلفن : ۳۷۱۳۳۰۰۰ - ۵۱